



Rail Accident Investigation Branch

Rail Accident Report



**Collision between an articulated tanker and a passenger train at Sewage Works Lane user worked crossing, near Sudbury, Suffolk
17 August 2010**

This investigation was carried out in accordance with:

- the Railway Safety Directive 2004/49/EC;
- the Railways and Transport Safety Act 2003; and
- the Railways (Accident Investigation and Reporting) Regulations 2005.

© Crown copyright 2011

You may re-use this document/publication (not including departmental or agency logos) free of charge in any format or medium. You must re-use it accurately and not in a misleading context. The material must be acknowledged as Crown copyright and you must give the title of the source publication. Where we have identified any third party copyright material you will need to obtain permission from the copyright holders concerned. This document/publication is also available at www.raib.gov.uk.

Any enquiries about this publication should be sent to:

RAIB	Email: enquiries@raib.gov.uk
The Wharf	Telephone: 01332 253300
Stores Road	Fax: 01332 253301
Derby UK	Website: www.raib.gov.uk
DE21 4BA	

This report is published by the Rail Accident Investigation Branch, Department for Transport.

Collision between an articulated tanker and a passenger train at Sewage Works Lane user worked crossing, near Sudbury, Suffolk 17 August 2010

Contents

Summary	5
Preface	6
Key Definitions	6
The accident	7
Summary of the accident	7
Organisations involved	8
Location	9
External circumstances	10
Train involved	10
The road vehicle involved	10
Persons involved	11
Events preceding the accident	13
Events during the accident	14
Events following the accident	15
The Investigation	16
Sources of evidence	16
Key facts and analysis	17
Identification of the immediate cause	17
Identification of causal contributory and underlying factors	17
Crashworthiness	44
Previous occurrences of a similar character	46
Observation	51
Summary of Conclusions	53
Immediate cause	53
Causal factors	53
Underlying factors	53
Factors linked to the consequence of the event	54
Additional observation	54

Actions reported as already taken or in progress relevant to this report	55
Actions reported that address factors which otherwise would have resulted in a RAIB recommendation	57
Recommendations	58
Recommendations to address causal, contributory, and underlying factors	58
Recommendations to address other matters observed during the investigation	60
Appendices	61
Appendix A - Glossary of abbreviations and acronyms	61
Appendix B - Glossary of terms	62
Appendix C - Key standards current at the time	63
Appendix D - The All Level Crossing Risk Model	64
Appendix E - Crashworthiness standards	66

Summary

At approximately 17:35 hrs on 17 August 2010, train 2T27, the 17:31 hrs service from Sudbury to Marks Tey, collided with a loaded 44 tonne articulated road tanker on Sewage Works Lane user worked crossing (UWC) near Sudbury in Suffolk. The collision caused the train to derail. Several passengers and the conductor on the train were injured in the collision; four passengers and the train driver were seriously injured.

The Rail Accident Investigation Branch's (RAIB) investigation has found that the driver of the road tanker did not use the telephone provided before driving onto the crossing, although it was a requirement to do so¹.

The company employing the road tanker driver had not been briefed by Anglian Water (to whom they were contracted) on how their staff could use Sewage Works Lane UWC safely.

The investigation also found that the long waiting times that road vehicle drivers sometimes experienced before being given permission to use the crossing at Sewage Works Lane led to a high level of non-compliance with the correct procedures for its use. Network Rail's processes relating to misuse at user worked crossings did not identify this issue and Network Rail's procedures for responding to misuse and near-miss incidents on user worked crossings were unclear and sometimes not complied with. Network Rail's data gathering exercises at Sewage Works Lane UWC (for the purposes of risk assessment) were characterised by errors and omissions and the amount of time devoted by Network Rail staff to analysing the results from the risk assessments and considering possible risk mitigation measures was limited. No single person or team in Network Rail had a complete understanding of the risk at Sewage Works Lane UWC.

The RAIB's investigation has also found that the design of the tables in the type of train involved at Sewage Works Lane may have exacerbated the consequences of the accident and that the signage at Sewage Works Lane UWC presented information in an unclear manner.

The RAIB has made six recommendations, covering the following areas:

- improving safety at Sewage Works Lane UWC;
- reminders to business users at user worked crossings of their responsibility to brief contractors on how to use such crossings safely;
- Network Rail's management of risk at crossings where there are long waiting times for road users;
- improvements in Network Rail's processes for gathering information at user worked crossings;
- changes to Network Rail's overall approach to the management of risk at level crossings; and
- a review of the crashworthiness performance of the tables in the type of train involved in the accident.

The Rail Safety and Standards Board (RSSB) has implemented research into signs at private railway crossings, thus obviating the need for the RAIB to make a recommendation to address this issue.

¹ On 27 November 2010, following an investigation undertaken by the Police (and independent of the investigation undertaken by the Rail Accident Investigation Branch), the driver of the articulated road tanker was convicted of the offence of endangering the safety of passengers on the railway.

Preface

- 1 The sole purpose of a Rail Accident Investigation Branch investigation is to prevent future accidents and incidents and improve railway safety.
- 2 The RAIB does not establish blame or liability, nor carry out prosecutions.

Key Definitions

- 3 All dimensions and speeds in this report are given in metric units, except speed and locations on Network Rail, which are given in imperial dimensions, in accordance with normal railway practice. For speeds, the equivalent metric value is also given.
- 4 All mileages in this report are measured from a zero datum at London Liverpool Street station.
- 5 This accident occurred at a user worked crossing. User worked crossings are provided where the railway crosses a minor (usually private) road, farm track or connection between fields. Only specifically authorised individuals and organisations have a right to cross the railway at that crossing. At such crossings, the user is required to operate gates or barriers when crossing the railway. Some user worked crossings are equipped with telephones and others are equipped with *miniature stop lights* (sometimes referred to as miniature warning lights) which provide users with an indication of whether a train is approaching or not.
- 6 The report contains abbreviations and technical terms (shown in *italics* the first time they appear in the report). These are explained in appendices A and B.

The accident

Summary of the accident

- 7 At approximately 17:35 hrs on 17 August 2010, train 2T27, the 17:31 hrs service from Sudbury to Marks Tey, collided with a loaded 44 tonne articulated road tanker on Sewage Works Lane UWC near Sudbury in Suffolk (figures 1 and 2).
- 8 The collision caused the leading *bogie* of the train to derail. There were 19 passengers on the train, a driver and a conductor. Several passengers and the conductor were injured in the collision; four passengers and the train driver were seriously injured. The tanker driver was uninjured. The train service on the branch line was suspended until 21:50 hrs on 19 August 2010.



Figure 1: Extract from Ordnance Survey map showing location of accident

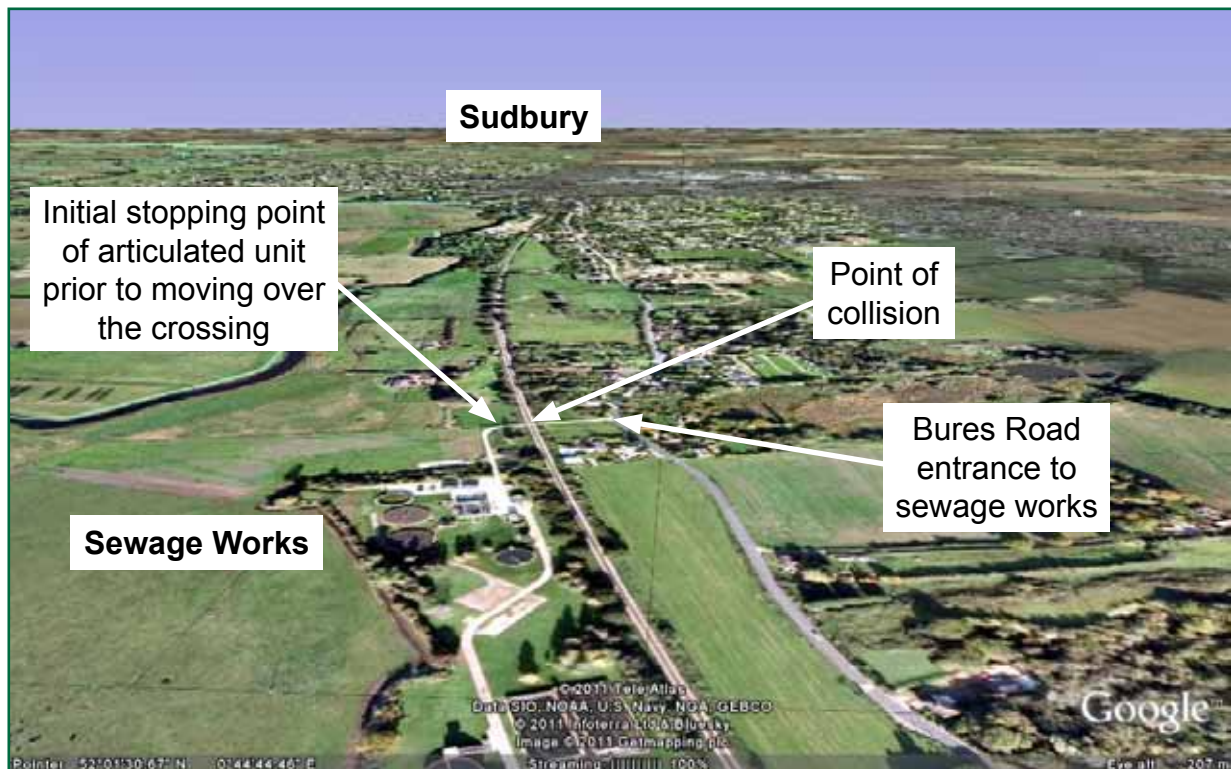

Figure 2: Overview of site showing geographical relationship of key features

Organisations involved

- 9 Network Rail is the owner and maintainer of the infrastructure at Sewage Works Lane UWC.
- 10 National Express East Anglia (NXEA) operates train services over the Sudbury branch line.
- 11 Anglian Water Services Limited is the owner of the sewage treatment works situated on the west side of Sewage Works Lane UWC. The company is an *authorised user* of the crossing. There are three other authorised users of the crossing; their primary reason for crossing the railway is to gain access to an adjacent stretch of water for fishing.
- 12 JK Environmental Services UK (JK Environmental) provides haulage services under contract to Anglian Water Services Ltd. It employed the tanker driver involved in the accident.
- 13 Porterbrook Leasing Company was the owner of the train involved in the accident.
- 14 All of the above parties that were consulted by the RAIB freely co-operated with the investigation.

Location

- 15 Sewage Works Lane UWC is located at 56 miles 62 chains on the branch line between Marks Tey in Essex and Sudbury in Suffolk, approximately two miles (3.2 kilometres) from Sudbury station (figure 3). It provides the principal vehicle access to the adjacent sewage treatment works. The crossing has a gate on each side of the railway. The gates are situated 12 metres from the nearest rail on the west (sewage works) side of the crossing and 8 metres from the nearest rail on the east side of the crossing. Telephones were² provided inside the gates on each side of the crossing. Signs positioned on the approach to both sides of the crossing instruct people using the crossing to open and close the gates, which are normally closed to the roadway. The signs also instruct the drivers of all road vehicles to call the signaller for permission to cross. At the time of the accident, the correct sequence of operation³ for a road user after arriving at the crossing was:
- open the gate, walk to the telephone and call the signaller for permission to cross;
 - if permission is not given, wait until the train passes and then ring the signaller again for permission to cross;
 - once permission is received, walk to the other side of the crossing and open the gate;
 - return to the vehicle and drive over the crossing and through the gateway on the other side;
 - telephone the signaller to confirm that the vehicle has safely crossed the line and close both gates.
- 16 The crossing is situated on a shallow embankment with ramps either side for road vehicles to climb up to the level of the crossing. The railway crosses an underpass located 26 metres south of the crossing which serves as pedestrian/cattle access between the fields on each side. The maximum permissible train speed is 50 mph (80 km/h) at this location.
- 17 The branch line has a single track and only one train at a time is permitted to be on the branch. *Track circuits* are only provided at Marks Tey and Sudbury stations. Signallers, who control the branch line from Liverpool Street Integrated Electronic Control Centre (IECC), are able to maintain an overview of the branch line on a screen, but have no indication of exactly where the train is located when it is travelling between Marks Tey and Sudbury. A signal is provided at Marks Tey, which is cleared by the signaller for the departure of a train to Sudbury. There is no signal at Sudbury and the driver of a train returning to Marks Tey calls the signaller by telephone for permission to depart. If the signaller has given permission for a road vehicle to use one of the user worked crossings on the route after the train has arrived at Sudbury, but has not received a call back from the user to confirm that the vehicle has crossed safely, the signaller is able to warn the driver of the train accordingly so that he approaches the relevant location at caution.

² Since the accident, the telephones have been moved so that the user can call the signaller without the need to go through the gate first.

³ The RAIB has some observations about the signage at the crossing in relation to the correct method of operation for a road user and these will be found at paragraph 191 of this report.

- 18 Trains run for approximately 18 hours per day with one train per hour in each direction. The running time for trains operating between Marks Tey and Sudbury is 20 minutes; 19 minutes is allowed in the opposite direction. The same train normally operates all services over the branch during a day. The amount of time spent at each end of the branch varies depending on the time of day, but the off peak timetable typically allows 5 minutes turnround for the unit at Sudbury and 16 minutes at Marks Tey.

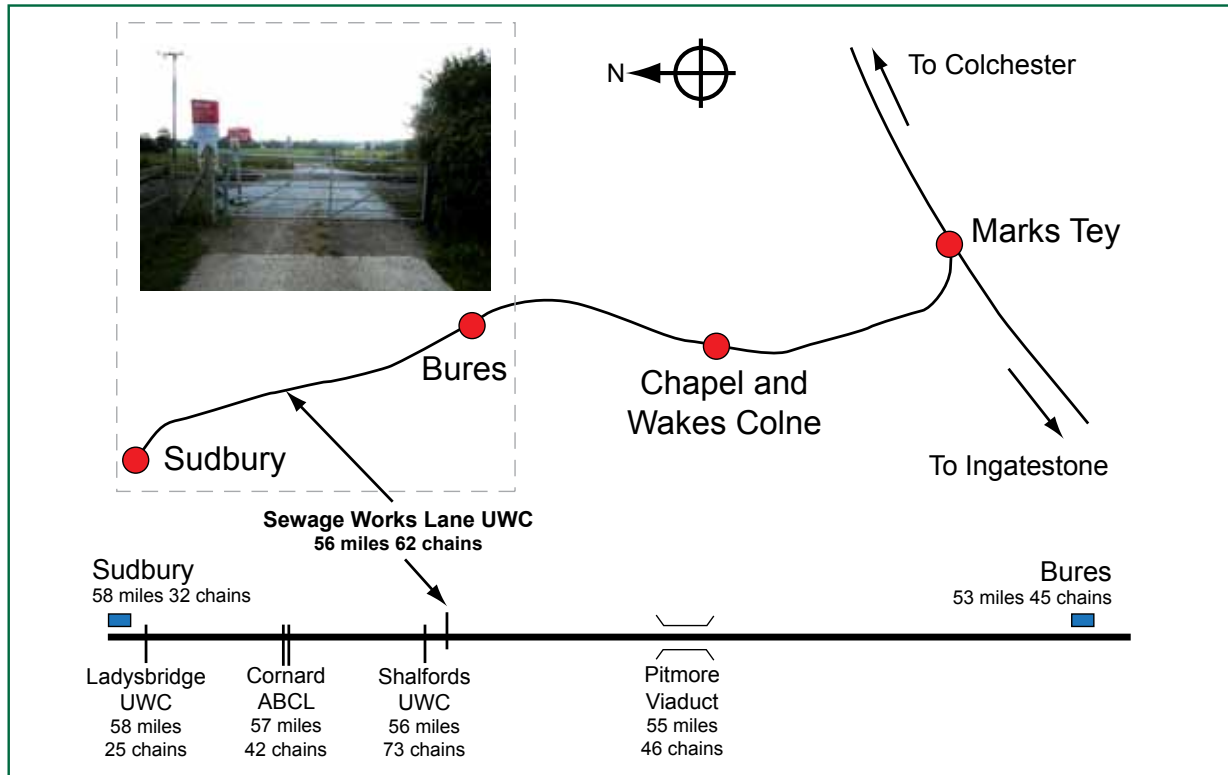

Figure 3: Map of railway infrastructure with image of crossing (inset)

External circumstances

- 19 The weather at the time of the accident was dry and the accident occurred in daylight hours.

Train involved

- 20 The train comprised a two-car class 156 *diesel multiple unit*.

The road vehicle involved

- 21 The 44 tonne large goods vehicle (LGV) involved in the collision at Sudbury comprised a tractor unit hauling a trailer on which was mounted a vacuum tanker used for waste disposal. It was similar to the vehicle shown in figure 4. The tractor unit was manufactured by Renault in 2007 and was equipped with automatic transmission. The combined tractor unit and trailer were approximately 14.2 metres in length. The tractor unit and trailer are collectively referred to as a 'tanker' in the remainder of this report.



Figure 4: Articulated tractor unit and tanker similar (but not identical) to that involved in the accident

Persons involved

The tanker driver

22 The tanker driver had been qualified to drive LGV (Class 1) vehicles since June 1997. He started work as a LGV driver in Lithuania and entered the UK in 2005. The driver had been employed by JK Environmental since January 2006 and had previously worked for a parcel delivery company for 3 months. There was no requirement for him to retake a driving test in the UK to obtain a UK LGV licence because he originated from a country that is part of the European Union; a UK LGV licence is issued on completion of a form and submission of the LGV licence obtained in the driver's country of origin.

Mobile Operations Manager

23 The Network Rail *Mobile Operations Manager* (MOM) who had undertaken the most recent safety assessment and data gathering⁴ exercise at the crossing had worked on the railway for nearly ten years. He started work within the maintenance department working on the track and was appointed as a MOM in 2007. In 2007 he had been trained by Network Rail to undertake periodic site visits at level crossings for the purposes of gathering data about features of the crossing (type, infrastructure provided, sighting distances, etc), its usage and other factors that might affect the risk to road or rail users at the crossing. His area of responsibility included the Sudbury branch line from 2009.

⁴ The MOM gathered data at the crossing as an input to a risk assessment which was undertaken by others. This is explained in much greater detail in paragraphs 130-144 in this report.

Operational Risk Control Coordinators

- 24 The Operational Risk Control Co-ordinators (ORCC) within Network Rail are responsible for checking data gathered by the MOM, making an overall assessment of the risk at the crossing based on that data and considering whether any additional steps need to be taken to mitigate the risk. They use Network Rail's *All Level Crossing Risk Model* (ALCRM) as one of the inputs to that decision. Network Rail's procedures require the ORCC to send a template letter to authorised users regarding forthcoming periodic risk assessment/ data gathering exercises. One part of that letter invites the authorised user to contribute to the risk assessment process. ORCCs may also write to authorised users at other times (eg after incidents involving crossing misuse and near-misses and on general matters relating to level crossing safety). Level crossings are only one of the elements that the ORCCs deal with; they are also responsible for following-up 'signal passed at danger' incidents, and any other safety incidents or accidents occurring within their designated geographical area of responsibility.
- 25 Sewage Works Lane UWC is located within Network Rail's Anglia Route. Each Anglia ORCC has up to 200 crossings for which they are nominally responsible. Between 2008 and the accident in 2010, two ORCCs had Sewage Works Lane UWC in their portfolio at different times:
- ORCC (1) joined Railtrack (the company responsible for the national railway infrastructure before Network Rail took over in 2002) in 1994 as a temporary member of staff working as a Team Organiser for Major Projects. She gained experience in various personal assistant roles within Railtrack and Network Rail before moving to the Anglia Route in 2006 as an Operations Clerk. She was appointed as an ORCC in July 2008 and at the time of appointment had no background in level crossings. The Operations Risk Advisor (see paragraph 26) took ORCC (1) out to visit crossings and to supervise her undertaking practical work including data gathering for ALCRM assessments. She had further training in the office on evaluating data gathered at crossings and attended a specific ALCRM course in September 2008. There was no probationary 'sign off' or formal mentoring process in place.
 - ORCC (2) had been in post since May 2010, having transferred from Network Rail's Human Resources team. At the time of appointment, she had no background in level crossings. She was trained in the use of ALCRM after appointment and had visited a small number of crossings in order to gain familiarity with the data gathering task. As with ORCC (1), there was no probationary 'sign off' or formal mentoring process in place for ORCC (2).
 - Between 2008 and 2010, the Anglia Operational Risk team comprised an Operations Risk Advisor (ORA) and, because of vacancies at different times, between one and three ORCCs. The team was assisted by a Technical Clerk who dealt with administrative matters, but this post was also vacant at times. From September 2009, the only member of the team with significant experience in level crossing risk assessment was one of the ORCCs (but not ORCC (1) or ORCC (2) referred to above).

Operations Risk Advisor

- 26 The ORCCs within a route are managed by an ORA. ORAs are required, amongst other things, to develop and implement plans for level crossing assessments to be undertaken in accordance with the requirements defined in Network Rail's Operations Manual (NR/L3/OCS/041). These requirements are discussed later in this report (paragraph 99 onwards).
- 27 The ORA for the Anglia Route in the period 2009-2010 had held a number of operations posts previously, including Station Manager at a London terminus and managing Liverpool Street IECC, before being seconded into the Anglia ORA role in September 2009 and formally appointed in January 2010. Before taking up the secondment in September 2009, she had been involved in investigating the operational risk team at Anglia in relation to allegations that had been made about irregularities in their working practices. This is also discussed later in the report (paragraphs 112 to 114).

Events preceding the accident

- 28 The tanker driver started work at 06:00 hrs on 17 August 2010 and performed various driving duties (interspersed with periods when he was not driving) before starting his journey to the treatment works alongside Sewage Works Lane UWC. By the time he reached that location he had been on duty for 11 hours and driving for 6 hours.
- 29 At approximately 17:00 hrs the tanker approached Sewage Works Lane UWC and then travelled over the crossing. The tanker driver did not call the signaller for permission to cross on his inward journey. The loading of the tanker within the sewage works was completed by around 17:25 hrs and the driver prepared his vehicle for departure and then returned towards the crossing, proceeding through the crossing gates and reaching the railway line (figure 5) at 17:33:30⁵ hrs.
- 30 Meanwhile, train 2T27 had departed from Sudbury at 17:31 hrs. At 17:33:14 hrs train 2T27 rounded a curve and Sewage Works Lane UWC came into view, approximately 490 metres distant. At this stage it is unlikely that the tanker was visible to the train driver because it was not yet on the crossing and the train driver's view of the western approach to the crossing was partially obscured by vegetation on the inside of the curve.
- 31 From this time onwards, the RAIB has not been able to establish an exact sequence of events because it is not known when the train driver first saw the tanker or at what speed the tanker was travelling as it approached the crossing and then drove onto it. The range of possibilities is discussed from paragraph 79 onwards. The remainder of this section contains the RAIB's assessment of the most likely sequence of events.
- 32 Approximately 8 to 10 seconds before the accident occurred, and with train 2T27 180 - 250 metres from the crossing, the train driver became aware of the front of the lorry approaching the crossing from the west side and then coming onto the railway. The train was travelling at 49.6 mph (79.8 km/h) at this time.

⁵ Where timings are given to the nearest second, they are based on information obtained from the on-train data recorder including a time stamp and train speed. However, there are some small uncertainties in relation to various factors such as those referred to in paragraph 31 which mean that the time that the events actually happened may differ by one or two seconds from that stated.



Figure 5: View from Sewage Works Lane UWC looking towards Shalfords UWC and Sudbury.

- 33 Realising that the tanker was not going to stop, the train driver applied the *emergency brake* 5 - 6 seconds before impact, when the train was approximately 120 metres from the crossing. The driver pushed the lever to sound the horn at around the same time as applying the emergency brake, but the RAIB has been unable to establish whether the horn actually sounded because its operation is not one of the recorded functions on the *On-Train Data Recorder* (OTDR) installed on the Class 156 unit involved in the accident.
- 34 The train driver left his cab and shouted a warning to passengers within the first carriage to advise them of the impending collision.

Events during the accident

- 35 At 17:33:40 hrs the train struck the tanker while travelling at 41 mph (66 km/h). Several passengers and the conductor were injured during the accident. Their injuries ranged from minor cuts and bruises to serious abdominal injuries. The train driver was thrown against the headwall of the vestibule area of the leading coach and suffered serious injuries.
- 36 The point of impact on the tanker was approximately 5 metres from the front of the tank and approximately 8.5 metres from the front of the tractor unit (figure 6). The tractor unit detached from the trailer as a result of the impact and the tank being conveyed on the trailer was breached, causing the contents to cascade over the train. The front of the leading coach of the train was severely damaged by the impact and the coach derailed, but remained upright at an angle, stopping approximately 35 metres beyond the crossing. The rear coach remained on the rails but suffered minor external damage. Both coaches had internal damage to doors, tables and fixings with some of the damage arising from passenger impact. The derailed coach damaged a short parapet alongside the track, with diesel fuel and effluent spilling into a pedestrian/cattle underpass (paragraph 16) below and onto the track.

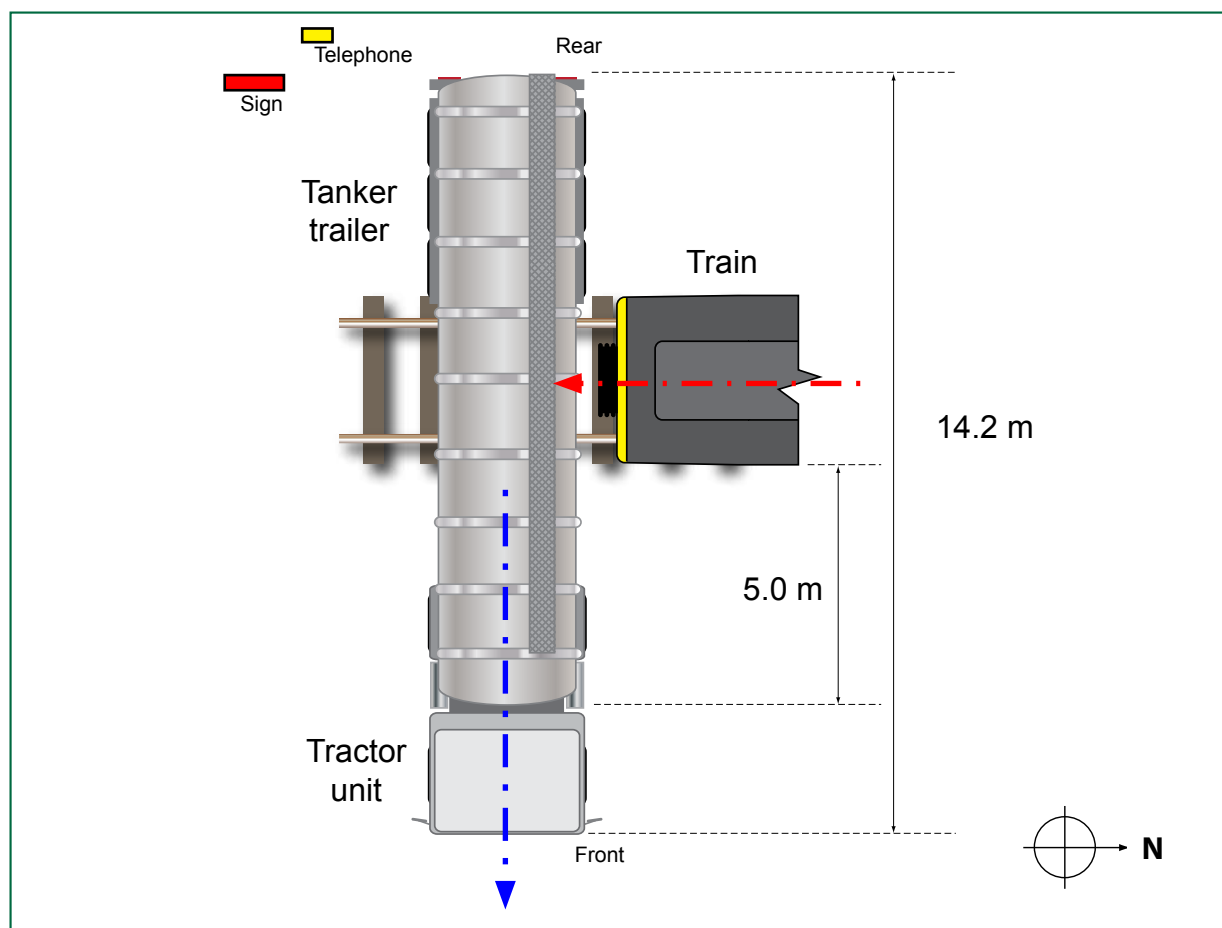

Figure 6: Diagram of point of impact.

Events following the accident

- 37 Shortly after the train stopped, the train driver made an emergency call from his mobile telephone and advised the signaller at Liverpool Street IECC of the accident. The signaller contacted the emergency services. Between 17.35 hrs and 17.47 hrs various other emergency calls were made from passengers on the train to the emergency services, with the first response units arriving on site at 17:40 hrs.
- 38 All of the passengers and train crew were evacuated in a controlled manner and people who had been injured were taken to hospital by land or air ambulance.

The Investigation

Sources of evidence

- 39 The following sources of evidence were used:
- witness statements;
 - examination of the train's internal and external structure;
 - the train's On-Train Data Recorder;
 - site photographs and measurements;
 - weather reports and observations at the site;
 - a reconstruction of the circumstances of the accident;
 - Network Rail's risk assessment files concerning the crossing and available historical documents;
 - RSSB research documents on the use of level crossings and risk assessment tools (these are identified with specific references later in this report);
 - Anglian Water risk assessment processes and documents;
 - JK Environmental training and risk assessment processes and documents;
 - control centre/signal box voice recordings and documents;
 - emergency service response logs;
 - standards & procedures issued by Network Rail, Anglian Water and JK Environmental;
 - details of previous reported occurrences at the crossing; and
 - previous RAIB investigations that had relevance to this accident.

Key facts and analysis

Identification of the immediate cause⁶

40 The tanker driver drove onto the crossing when it was not safe to do so.

Identification of causal⁷ contributory⁸ and underlying factors⁹

Non-use of the telephone by the tanker driver

41 The tanker driver did not use the telephone before crossing the line, although the signs at the crossing indicated that anyone crossing with a vehicle should telephone the signaller before doing so. This was a causal factor in the accident.

42 The tanker driver admitted (to the Police) that he had not used the telephone, and there was no voice recording of any telephone call having been received at Liverpool Street IECC. Testing of the telephones on site could not be carried out after the accident as the telecommunication cables had been severed in the accident. There had been no reported failure of the telephones in the period leading up to the accident and the last test of the telephones by maintenance staff on 25 May 2010 showed that they were working correctly. Records held in Liverpool Street IECC indicate that the telephone was last used at Sewage Works Lane UWC at 16:56 hrs on 16 August 2010 (the day before the accident).

43 Network Rail's instructions governing operation of the Sudbury branch line require the signaller to ask road vehicle drivers seeking permission to cross at Sewage Works Lane UWC to wait unless the signaller knows exactly where the train is. In practice, this means that the signaller should only give permission if he can tell from his display screen (paragraph 17) that the train is at Marks Tey or Sudbury stations and has not been signalled (Marks Tey) or given permission (Sudbury) to depart, or if the crossing user is able to confirm that the train has recently passed.

44 Had the tanker driver called the signaller, it is likely that he would have been told to wait until the train had passed, as his phone call would have been received at about the time train 2T27 was leaving Sudbury (17:31 hrs).

45 The RAIB has considered why the tanker driver did not use the telephone. A number of possible reasons are discussed in the following paragraphs:

- the tanker driver did not know how to use the crossing safely;
- the tanker driver was suffering from fatigue and this led him into making a mistake;

⁶ The condition, event or behaviour that directly resulted in the occurrence.

⁷ Any condition, event or behaviour that was necessary for the occurrence. Avoiding or eliminating any one of these factors would have prevented it happening.

⁸ Any condition, event or behaviour that affected or sustained the occurrence, or exacerbated the outcome. Eliminating one or more of these factors would not have prevented the occurrence but their presence made it more likely, or changed the outcome.

⁹ Any factors associated with the overall management systems, organisational arrangements or the regulatory structure.

- the tanker driver did not wish to be delayed and feared that he might be if he called the signaller;
- the tanker driver was preoccupied with other matters and did not focus on safe use of the crossing; or
- the tanker driver had not been briefed on safe use of the crossing by his employer, JK Environmental.

The tanker driver's knowledge of how to use the crossing safely

46 The tanker driver had visited the site adjacent to Sewage Works Lane UWC on one previous occasion, two months before the accident. On that occasion, he had read the signs requiring him to call the signaller and had used the telephone before crossing the railway. After crossing the line he did not call the signaller back to advise that he was clear of the crossing. On his return journey he again telephoned the signaller before crossing (figure 7). The signaller explained to the tanker driver that he should also have called once he had negotiated the crossing safely on his inward journey. The tanker driver crossed the railway and called back to advise he was clear. Records held in Liverpool Street IECC do not show that he was subject to any delay on this visit, although the tanker driver said that he waited for a long time before the signaller answered the phone.



Figure 7: View of the crossing from the exit of the sewage treatment works.

47 Since the tanker driver had read the signs and called the signaller on his first visit to the crossing, and had then received a specific briefing on other aspects of safe usage of the crossing, the RAIB concludes that the tanker driver was probably aware of how to use the crossing safely.

Fatigue affecting the tanker driver's actions

- 48 The tanker driver's working time records were examined by the Police in relation to the period from 21 June to 15 August 2010. The average number of working hours per week was 69 (although not all of this time was spent driving). The driver had signed a working time directive disclaimer allowing him to work overtime for the company within the European Union limitations on driving hours for LGV Class 1 drivers. The records showed there were no driving infringements in relation to his driving hours.
- 49 In the three days leading up to the accident, the tanker driver had two rest days followed by a 06:00 hrs to 18:00 hrs shift on 16 August 2010. He had retired to bed at around 20:00 hrs.
- 50 He started work on 17 August 2010 at 06:00 hrs. He had been on duty for almost 12 hours and driving for a total of 6 hours at the time that the accident occurred at 17:33 hrs. European Union rules permit nine hours driving per day (ten hours on a maximum of two days per week). Time spent on other duties (such as loading the tanker) is not counted in the calculation of driving time.
- 51 The RAIB has considered whether the tanker driver might have been suffering fatigue to the extent that his performance was impaired. There are a number of factors that suggest that fatigue is an unlikely explanation for his actions:
- he had only just started driving after loading his vehicle in the sewage treatment works and had not yet settled into the predictable routine of driving that can sometimes be a precursor to tiredness arising from fatigue;
 - although he had been working long hours in the weeks before the accident, he had taken two rest days in the three days preceding the accident;
 - the long hours that he had worked contained rest periods when he was inactive; and
 - he did not claim to have been feeling tired.
- 52 For the reasons described above, the RAIB considers it unlikely that the tanker driver was suffering from fatigue at the time of the accident to the extent that it would have affected his judgement about using the telephone before crossing.

The effect of possible delays on the tanker driver's actions

53 The long waiting time that road vehicle users sometimes experienced at the crossing before being given permission to cross led to a high level of non-compliance with the correct procedures for using Sewage Works Lane UWC. This was an underlying factor in this accident.

- 54 Road crossing users might have to wait up to 19 minutes before being given permission by the signaller to cross the line at Sewage Works Lane UWC. This provided a disincentive for them to telephone the signaller before crossing.
- 55 Witness evidence indicates that some authorised users were frustrated by the length of time that they had to wait on occasions when crossing with a road vehicle at Sewage Works Lane UWC. The branch is not track circuited and the signaller only knows when the train is at Marks Tey or Sudbury stations. Consequently, the signaller can only give road vehicle users permission to cross under the circumstances described in paragraph 43.

- 56 After the accident, Anglian Water staff were requested to record waiting times at Sewage Works Lane UWC during October 2010. The following data was reported from the 25 drivers who responded:
- the shortest waiting time was 1 minute;
 - the longest waiting time was 36 minutes (15 October 2010); and
 - the average waiting time was 11 minutes.
- 57 RAIB correlated this data against the documentation that signallers at Liverpool Street IECC maintained during the same period regarding phone calls received from Sewage Works Lane UWC:
- the shortest waiting time was 1 minute;
 - the longest waiting time was 19 minutes (15 October 2010);
 - the average waiting time was 8 minutes; and
 - the majority of users experienced waiting times of between 6 and 12 minutes.
- 58 Between 16 December 2009 and 16 August 2010, the log book used to record the date and times of all employees and contractors visiting the sewage works showed that there had been 425 visits to the installation. The railway would therefore have been crossed at least 850 times (there is no other exit from the sewage works site).
- 59 Each visit to the sewage works should yield two entries in a table maintained by the signaller at Liverpool Street IECC, as the request to use the crossing is recorded on the same line in the table as the confirmation that the user is safely over the crossing. The records at Liverpool Street IECC show there were only 254 entries in this period instead of the 850 entries which would have been indicative of full compliance. On the assumption that signallers had always recorded details of every telephone request to use the crossing, the compliance rate with the requirement to call the signaller was around 30% (ie around 600 crossings were made without a call being made to the signaller). In practice, as some of the records may relate to use of the crossing by other authorised users, the compliance rate amongst drivers using the crossing for the purposes of attending the sewage works could have been lower than 30%.
- 60 Witness evidence suggests that the delays were common knowledge amongst drivers from JK Environmental and the subject of discussion between them. It is therefore probable that the level of misuse at the crossing was directly linked to the long waiting times that road users experienced before being able to cross.
- 61 The tanker driver had been on duty since 06:00 hrs and still had to drive to Harwich and return to the company's base at Royston before completing his shift. Depending on whether he was delayed or not, he would probably have finished work between 20:00 hrs and 21:00 hrs. The RAIB understands that the tanker driver may have had personal reasons for wanting to get home as quickly as possible.

- 62 It is therefore possible that the tanker driver did not wish to incur delay by telephoning the signaller and being told that he might have to wait before being given permission to cross the line. Had those delays not been a feature at Sewage Works Lane UWC, there would have been less incentive for non-compliance with the requirement to call the signaller, and the accident might have been avoided.
- 63 The specific issue of risk at level crossings where users might have to wait a long time for permission to cross the railway is recognised in Section 10 of *Railway Safety Principles and Guidance*, Part 2, Section E on level crossings. Paragraph 133(c)(ii) states:
- ‘Miniature stop lights should be provided on both sides of the crossing where...the information supplied (by a signaller to a user via a telephone) would be so restrictive that it would be likely to cause the user to become unduly impatient and to cross without permission.’
- The reasons why such risk mitigation measures were not applied at Sewage Works Lane UWC are discussed later in this report.
- 64 Managers at Anglian Water have stated that they were unaware that some of their staff and contractors were not complying with the laid down requirements for using the crossing safely. However, they had recognised in 2009 that delays were occurring at the crossing as they had looked at options for by-passing the crossing, which were deemed too expensive. The exercise was undertaken for operational reasons; they had not specifically considered the safety implications that might arise from predictable delays.

Other matters preoccupying the tanker driver

- 65 **The tanker driver may have been preoccupied with non-work related matters as he approached and crossed Sewage Works Lane UWC, resulting in a lack of focus on the safe method of crossing the railway. This was possibly a causal factor in the accident.**
- 66 As referred to in paragraph 61, the RAIB understands that the tanker driver may have had personal reasons for wanting to get home, which may have led to him wishing not to be delayed and thus consciously deciding not to telephone the signaller before using the crossing.
- 67 It is also possible that he was preoccupied with non-work matters to the extent that he did not give sufficient attention to crossing the railway safely, focusing on the tasks that required positive action to make progress (opening the gates and driving his vehicle over the crossing), rather than reading the signs and checking for trains as he approached the crossing.

Briefing of the tanker driver on safe use of Sewage Works Lane UWC

- 68 **JK Environmental did not brief the tanker driver on how to use Sewage Works Lane UWC safely. Anglian Water did not brief JK Environmental on how their staff could use Sewage Works Lane UWC safely. This was possibly a causal factor in the accident.**

- 69 In common with other utility companies in the United Kingdom, Anglian Water uses the 'Achilles' verification process¹⁰ to highlight the hazards associated with the work that they undertake. It covers the employment of contractors such as JK Environmental. Part of the process in relation to contractors requires an external auditor to visit the premises of the company and check a number of safety aspects of the contractor's performance, including environmental quality and health and safety compliance. JK Environmental had scored well in the audits.
- 70 Anglian Water provided JK Environmental with a non-exhaustive generic list of all the potential hazards that were considered to be relevant to the task-specific work it was performing. This was supplied in the form of a specification, which listed the type of work Anglian Water expected the contractor to undertake and the hazards involved in the task. It asked contractors to provide Anglian Water with risk assessments that adequately controlled those hazards. Anglian Water's safety team assessed the quality of the assessments. JK Environmental's risk assessments did not include any reference to level crossings, because they were not included in Anglian Water's specification. JK Environmental's risk assessment was accepted by Anglian Water.
- 71 JK Environmental's managers did not consider the risk at this crossing to be any different from the generic risk at any railway level crossing on a public road. The safety issues and previous near-miss incidents at level crossings had not come to the notice of the company and had not been raised by any individual employee, or by any of the companies for which JK Environmental worked.
- 72 Anglian Water held a licence as authorised user of Sewage Works Lane UWC. A condition of the licence was that the licensee would not use the level crossing 'unless informed by telephone by the signaller that it is safe to do so'. Where the authorised user of a crossing is a company, using the crossing in connection with a business, it has duties under the Health & Safety at Work etc Act 1974 to conduct its undertaking in a way which does not expose its employees or others (such as railway staff, passengers and contractors) to risk.
- 73 Anglian Water's site-specific risk assessment for the facility adjacent to Sewage Works Lane UWC described how staff have to call the signaller to get authority to cross the railway before and after visiting the sewage works, and the requirement to close the gates after each crossing. The risk assessment was generated in 2007 and had been reviewed yearly with the last review on 24 June 2009. The requirement was briefed to staff working at the location, but not briefed to other staff or contractors who visited the site.

¹⁰ The Achilles verification system was introduced in 1990 and is a recognised utility companies audit and monitoring process used to identify, qualify, evaluate and monitor suppliers on behalf of major organisations in the UK and worldwide.

- 74 Anglian Water had produced a site induction DVD for the Sewage Works Lane facility and this was briefed to all new Anglian Water staff and contractors (including JK Environmental). The DVD did not include site specific hazards and did not include any reference to the hazards associated with crossing the railway. The company considered that because all staff using road vehicles had a UK driving licence and were therefore familiar with the Highway Code, this would equip them with the necessary information and competence to use the level crossing safely. Paragraphs 296 and 297 of the Highway Code include general advice on how to cross safely at user worked crossings (paragraph 295 is also included as it is referred to in paragraph 297):
- ‘295 **Crossings without traffic lights.** Vehicles should stop and wait at the barrier or gate when it begins to close and not cross until the barrier or gate opens.
- 296 **User-operated gates or barriers.** Some crossings have ‘Stop’ signs and small red and green lights. You **MUST NOT** cross when the red light is showing, only cross if the green light is on. If crossing with a vehicle, you should
- open the gates or barriers on both sides of the crossing
 - check that the green light is still on and cross quickly
 - close the gates or barriers when you are clear of the crossing
- 297 If there are no lights, follow the procedure in Rule 295. Stop, look both ways and listen before you cross. If there is a railway telephone, always use it to contact the signal operator to make sure it is safe to cross. Inform the signal operator again when you are clear of the crossing.’
- 75 Senior managers within Anglian Water were not aware of any previous briefings that had been triggered by incidents of misuse or near-misses at Sewage Works Lane UWC (these are described in table 4, following paragraph 102), but they were aware of a safety leaflet (Track Safe Code) that was originally sent to Anglian Water in 2003 following discussions between a local Network Rail crossing inspector and the sewage works manager.
- 76 Anglian Water had not had any recent briefings from Network Rail with regards to the hazards at Sewage Works Lane UWC or level crossings generally. There was no record of any correspondence or discussions between Network Rail and Anglian Water after 2005.
- 77 However, witness evidence indicates that Anglian Water had become aware of a near-miss between a train and a LGV driven by an employee of another company in August 2009 (see table 4 and paragraph 102). Despite this knowledge Anglian Water did not revisit its own risk assessment, re-brief its own staff and contractors on the safe use of the crossing or discuss the matter with Network Rail.
- 78 After the accident, Anglian Water adopted measures which it intended would ensure that staff and contractors complied with the correct method for using the crossing. These included dismissal for staff failing to telephone the signaller before crossing.

Visibility at the crossing

Sighting for tanker driver and train driver in the period immediately before the collision

- 79 Although the tanker driver did not use the telephone before crossing the railway at Sewage Works Lane UWC, the accident might still have been avoided, or the consequences reduced, if the tanker driver had seen the train before his vehicle encroached on the railway or if the train driver had seen the tanker coming onto the railway in time to stop his train or substantially reduce its speed.
- 80 The RAIB undertook a series of sighting tests at Sewage Works Lane UWC on 3 October 2010. The tests involved the tractor unit from the tanker involved in the collision and a Class 153 unit, the cab layout of which is similar to the Class 156 unit involved in the accident on 17 August 2010.
- 81 The tests involved positioning the tractor unit and the train at different distances from the crossing and determining when one would be visible from the other. Tables 1 and 2, below, provide a summary of the key findings from this exercise.

Distance between front of tanker and nearer running rail (metres)	Train driver's ability (Yes / No / Partial) to see the tanker at various distances from the crossing (train's position measured from the front of the train to the centre of the crossing in metres)							
	490	400	300	250	200	150	100	0
4	P*	P*	N ⁺	P*	N ⁺	P*	P*	Y
3	Y	Y	N ⁺	Y	Y	Y	Y	Y
2	Y	Y	P*	Y	Y	Y	Y	Y
0 (at nearest rail)	Y	Y	Y	Y	Y	Y	Y	Y

* Partial visibility indicates that the presence of vegetation would have prevented the train driver from having an unobstructed view of a vehicle approaching the crossing

+ No visibility indicates the road vehicle would have been completely obscured.

Table 1: Sighting of a vehicle at Sewage Works Lane UWC from an approaching train

Distance between the front of the train and the crossing (metres)	Tanker driver's ability (Yes / No / Partial) to see the train at various distances from the crossing (tanker's position measured from the front of the vehicle to the nearer running rail in metres)			
	4	3	2	0 (at nearest rail)
490	P*	Y	Y	Y
400	P*	Y	Y	Y
300	N ⁺	Y	Y	Y
250	P*	Y	Y	Y
200	Y	Y	Y	Y
150	P*	Y	Y	Y
100	Y	Y	Y	Y

* Partial visibility indicates that the presence of vegetation would have prevented the tanker driver from having an unobstructed view of a train approaching the crossing

+ No visibility indicates the train would have been completely obscured.

Table 2: Sighting of an approaching train from a vehicle at Sewage Works Lane UWC

- 82 The damage inflicted on the tanker by the train provides a clear indication of where the tanker was on the crossing when it was struck. The left side of the damage (as viewed from the train) was approximately 5 metres from the front of the tank and approximately 8.5 metres from the front of the tractor unit.
- 83 The RAIB has calculated that the distance travelled by the tanker, from the earliest time that the train would have been visible from the tanker and vice versa (when the front of the tanker was four metres from the nearer running rail – see tables 1 and 2), was approximately 14 metres, comprising the 4 metres to reach the nearer running rail, the 1.4 metres between the two running rails and the 8.5 metres travelled beyond the farther running rail (and including a small allowance because the sides of the train are outside of the running rails).
- 84 The tachograph fitted to the tractor unit of the tanker involved in the collision registered the vehicle's speed as it approached and negotiated the crossing as 3 mph (4.8 km/h), having started from a position approximately 15 metres from the nearer rail (the position at which it had previously stopped for the tanker driver to open the gates). The RAIB understands that the tachograph does not register speeds below 3 mph (4.8 km/h).
- 85 Table 3, below, provides an indication of when the tanker would have been 4 metres from the nearer running rail, if it is assumed that it ran at constant speeds ranging from 2 mph (3.2 km/h) to 4 mph (6.4 km/h)¹¹.

Speed of LGV mph (m/s)	Elapsed time between tanker being 4 metres from the nearer running rail and time of impact (seconds)*	Approximate distance of train from crossing (metres)*
2 (0.894)	15.7	348
3 (1.341)	10.4	231
4 (1.788)	7.8	173

* The calculation is based on data from the train's OTDR which shows that the train was travelling at 49.6 mph (22.173 m/s) until the driver applied the emergency brake 5-6 seconds before impact, with speed reducing to 41 mph at time of impact – it takes approximately two seconds for the brakes to build-up pressure once applied.

Table 3: Estimation of elapsed time and train position between the LGV being 4 metres from the nearer rail and the collision

- 86 Taking table 3 into account, the following two sections consider:
- the actions taken by the tanker driver as he approached and negotiated the crossing; and
 - the actions taken by the train driver as he approached the crossing.

¹¹ European Union rules permit variations of ± 6 km/h in speed recording accuracy on a tachograph once fitted, although some makers of digital tachographs claim accuracies of ± 1 km/h.

The tanker driver's view of the train

- 87 **The tanker driver did not see (and may not have looked for) the train as he approached Sewage Works Lane UWC. This was a causal factor in the accident.**
- 88 Table 2 shows that it is possible to see a train approaching from the Sudbury direction when a road vehicle is three metres from the crossing and it may be possible to see it when a road vehicle is four metres from the crossing. Irrespective of the speed at which the vehicle was travelling (up to 4 mph (6.4 km/h), see paragraph 85), the tanker driver would have had an opportunity to look for and therefore see an approaching train and stop the vehicle before it encroached onto the crossing.
- 89 The tanker driver said that he did not see the approaching train. The RAIB's tests on 3 October 2010 showed that it is possible that the array of mirrors located on the nearside of the tractor unit might obstruct the tanker driver's view of an approaching train (see figures 8 -10). However, the obstruction is easily overcome by the tanker driver moving his head backwards or forwards, an action that he would have been used to performing when joining or crossing a main road from a side road.



Figure 8: View of train taken from the tanker vehicle driving position showing the train beyond Shalfords UWC at around 500 metres (Photograph from the sighting tests on 3 October 2010)



Figure 9: View of tanker from the train driving position at 200 metres (Photograph from the sighting tests on 3 October 2010)



Figure 10: Effect on tanker driver's view of an approaching train caused by the mirror cluster on near-side of tanker (Photographs from the sighting tests on 3 October 2010)

The train driver's view of the tanker

- 90 For the reason described in paragraph 84, it is not possible to determine with any degree of accuracy the speed at which the tanker approached and crossed Sewage Works Lane UWC. It is therefore not possible to say exactly when the tanker would have been visible to the train driver. Limited observations and timings undertaken by the RAIB indicate that tankers cross at a speed of around 4 mph (6.4 km/h), but this was after their drivers had telephoned the signaller and there is no certainty that the drivers of these vehicles drove in exactly the same way as the driver of the tanker involved in the collision on 17 August 2010. The speed of the vehicle is slow because of the need to negotiate the slight rise on the approach to the crossing and the slight fall the other side, taking account of the surface on the approach to the crossing and on the crossing itself. The actual speed will be dependent on factors such as the weight and condition of the vehicle and the performance of the automatic gearbox/engine of the specific vehicle involved.
- 91 However, based on the contents of table 3, the RAIB makes the following observations about sighting times for the train driver:
- Had the tanker been travelling at an average speed of 2 mph (3.2 km/h), it would have been four metres from the nearer rail when the train was approximately 350 metres from the crossing. Table 1 shows that this coincides with a distance where the view from the train towards the crossing is obscured or partially obscured over a length of 100 metres. However, once the train was 250 metres from the crossing, the front of the tanker would have been in view, at which point the train would have been approximately 10.5 seconds running time from the crossing. As the driver applied the train's brakes 5-6 seconds before impact occurred, in this scenario, the train driver would have taken about five seconds to react to the presence of the tanker. This delay might be attributed to the train driver not immediately seeing the tanker (his focus might have been elsewhere) or not immediately realising that the tanker was moving because of its low speed. Witness evidence from train drivers on this route indicates that road vehicles were occasionally seen stationary in close proximity to the railway. This may have happened because the telephones could not be reached without opening the gates and some drivers may have driven their vehicles through the gates and onto Network Rail's land (but clear of the railway) before using the telephone. The RAIB has estimated that in this scenario, had the train driver applied the brakes within two and a half seconds (allowing for reaction time), the speed of the train would have been reduced to approximately 32 mph (52 km/h) and the train would have struck the trailer at a point 10.6 metres from the front of the vehicle.
 - Had the tanker been travelling at an average speed of 3 mph (4.8 km/h), it would have become visible to the train driver when the train was 10.4 seconds from the crossing. This is similar to the case described above for a tanker speed of 2 mph (3.2 km/h) where the train driver's view of the approaching tanker is obscured until he is approximately 10.5 seconds running time from the crossing.
 - Had the tanker been travelling at an average speed of 4 mph (6.4 km/h), it would have become visible to the train driver when the train was 7.8 seconds from the crossing. Allowing for the train driver's reaction time, this is compatible with an emergency brake application 5-6 seconds from the time of impact.

- 92 While it can never be established with certainty when the tanker first became visible to the train driver, the scenarios discussed in paragraph 91 lead the RAIB to conclude that the train driver's actions were not causal to the accident and were unlikely to have contributed to its severity. Even if it is assumed that the train driver had seen the tanker when the train was around 250 metres from the crossing and braked earlier, the accident would still have occurred, albeit at lower speed. It should also be noted that the driver of the train involved in the accident on 17 August 2010 had also been involved in a near-miss incident in August 2009 at Sewage Works Lane UWC (table 4). It might therefore be expected that he would have had a heightened awareness of the hazards from road vehicles at this crossing and have been particularly vigilant when approaching this location.

Network Rail's awareness of the extent of misuse at Sewage Works Lane UWC

93 Network Rail's processes for identifying misuse at user worked crossings were not effective in establishing the actual level of misuse at Sewage Works Lane UWC. This was an underlying factor in the accident.

- 94 Procedure 5-19 in Network Rail's Operations Manual (Company Standard NR/L3/OCS/041) defined misuse at a user worked crossing as any one of:
- crossing of the line during the approach of a train (not close enough to be a near-miss);
 - non-use of a telephone when provided (except for failure to call-back after using the crossing);
 - leaving gates open.
- 95 The definition of 'non-use of a telephone when provided' as misuse meant that there was a high probability that the extent of misuse would be under-reported. Unless a near-miss occurred, or a gate was left open, there was no way in which Network Rail could know when a road vehicle had crossed the line without its driver using the telephone first.
- 96 It was only because visitors to the sewage works facility were required to record their presence that the RAIB was able to establish the extent of misuse at the crossing (paragraphs 58 and 59), which was significantly higher than Network Rail's own records indicated (see table 4). As each event of non-use of the telephone carried with it the potential for an accident, it is possible that Network Rail might have taken action to address the high level of misuse, had it been aware of the extent to which it was taking place.

The response to previous incidents at Sewage Works Lane UWC

97 Network Rail's procedures for responding to incidents involving near-misses and misuse at user worked crossings are unclear and resulted in a lack of engagement with Anglian Water over the history of such incidents at Sewage Works Lane UWC. This was an underlying factor in the accident.

- 98 Routine risk assessments are scheduled to be undertaken once every three years at user worked crossings. However, additional 'trigger' risk assessments are undertaken in defined circumstances associated with near-miss or misuse incidents.

- 99 Network Rail's Operations Manual (paragraph 94) prescribed that a risk assessment must be undertaken after three misuse events in a twelve-month period, unless a routine risk assessment had been undertaken in the previous six months or an assessment triggered by a near-miss or three misuse incidents had already been undertaken in the previous twelve months.
- 100 The same standard defined a near-miss as crossing of the line during the approach of a train by vehicles or pedestrians necessitating emergency braking to be initiated by the train driver or too late for avoiding action to be taken. The prescribed action was as described for misuse, except that the action was to be taken after a single near-miss incident.
- 101 The RAIB has been unable to establish exactly how many near-miss and misuse incidents occurred in the five years leading up to the accident on 17 August 2010. There are a number of reasons for this:
- The definitions of misuse in relation to an approaching train (paragraph 99) and the definition of near-miss (paragraph 100) left open for interpretation which category a specific incident might fall into. The classification of an incident as a near-miss or otherwise is performed by personnel who input data into the industry's *Safety Management Information System* (SMIS), based on the driver's report and any other information available. Therefore the driver who experiences the incident is not involved in its classification and the person responsible for classifying the incident has no direct knowledge of its circumstances. The RAIB's report into safety of user worked crossings (13/2009) showed that incidents were recorded as a 'near-miss' if the train driver considered that a collision had been narrowly avoided. The investigation showed that data was not sufficiently reliable to enable conclusions about near-misses based on train drivers' reports alone to be drawn.
 - The source of data used by Network Rail for identifying when near-miss or misuse incidents occurred was SMIS. The RAIB compared the data within SMIS with other data such as the level crossing occurrence book held at Liverpool Street IECC, records kept by the Anglia Operational Risk team and other correspondence. It was found that the number of near-miss incidents and misuse did not correlate.
 - There was significant lack of awareness of the number of incidents involving non-use of the telephone before crossing the line (paragraphs 59 and 95).
- 102 Table 4 provides a summary of recorded misuse and near-miss incidents in the five years preceding the accident and the action taken in response to those incidents. It is based on the following data sources:
- SMIS;
 - Network Rail Anglia Operational Risk team's own database of incidents at the crossing;
 - RAIB's review of the occurrence book at Liverpool Street IECC.

Year	Description of the incident	Action
2005	Near-miss between a train and a van (June)	Letters were sent to all authorised users including Anglian Water.
2006	Near-miss between a train and a lorry (June)	No evidence of any follow-up action. Incident does not appear on Anglia Operational Risk team's database of incidents at the crossing.
	LGV crossed in front of a train (August)	The incident was classified as misuse. No further action was required. Incident does not appear on Anglia Operational Risk team's database of incidents at the crossing.
	Gates left open at crossing (August)	The incident was classified as misuse. No action required*.
2007	A van crossed in front of a train (April)	The incident was classified as misuse. No action required*
	A near-miss occurred between a train and a tractor (October)	The ORCC and ORA undertook a site visit (no trigger risk assessment was required because a routine risk assessment had been undertaken in June 2007). The only risk mitigation measure deemed to be applicable was to write to the authorised users. Anglian Water had no record of receiving a letter from Network Rail.
	'A person' crossed despite being refused permission from the signaller (November 2007)	Classified as misuse and assumed to be a vehicle (pedestrians not required to call the signaller). No action required*.
	A tanker crossed in front of a train (December)	The incident was classified as misuse. No action required*.
	Three other misuse incidents were reported during the year	They involved users not calling back after crossing and were not misuse as defined in Operations Manual Procedure 5.19
2008	A near-miss occurred between a flat-bed truck and a train (July)	Network Rail undertook a trigger risk assessment as a response to both incidents which had occurred within three weeks of each other. No risk mitigation measures were deemed to be applicable. Anglian Water had no record of receiving a letter from Network Rail.
	A near-miss occurred between a van and a train (July)	
	Two incidents of misuse were reported during the year	These involved vehicles crossing without permission. No action required*.
2009	A near-miss occurred between a train and a LGV (August)	A trigger risk assessment was undertaken following the near-miss incident. Data gathering may have been undertaken at the wrong crossing (see paragraph 138).
	Two misuse incidents were reported during the year	They involved users not calling back after crossing and were not misuse as defined in Operations Manual Procedure 5.19
2010	Two incidents of misuse recorded before the accident on 17 August.	They involved users not calling back after crossing and were not misuse as defined in Operations Manual Procedure 5.19
* No action required for the reasons described in paragraph 99, relating either to not meeting the threshold in terms of the number of near-miss incidents in a year or routine or trigger risk assessments having taken place within the last year		

Table 4: Near-miss and misuse history at Sewage Works Lane crossing 2005-2010

- 103 Table 4 shows that in the five years before the accident in August 2010, there were at least 6 recorded near-misses and at least 14 recorded incidents of misuse at Sewage Works Lane UWC (although 9 of the misuse incidents recorded by Anglia Route involved a user failing to call the signaller after crossing, which Network Rail's procedures did not classify as misuse). Despite this history, Network Rail did not approach the authorised users (including Anglian Water) to discuss the crossing's near-miss and misuse history.
- 104 The RAIB has considered why there was a lack of engagement between Network Rail and Anglian Water over the near-miss and misuse incidents.
- 105 Although Network Rail's procedures required that a letter inviting participation in level crossing risk assessments should be sent to each authorised user for routine risk assessments, there was no explicit requirement for Network Rail to correspond with authorised users when they were undertaking risk assessments in response to three incidents of abuse or one near-miss¹². Network Rail did not invite authorised users to participate in any of the trigger risk assessments referred to in table 4.
- 106 Following risk assessments, Network Rail uses a web-based system known as the Level Crossing Risk Management Toolkit to identify risk mitigation options. The toolkit comprises a generic listing of options for consideration and indicative costs for each one. Although various risk mitigation options were available including local education campaigns and involving users in the risk assessment process (all classified as low cost (£0 - £10,000)), ORCCs could filter the options presented to produce a list relevant to the type of crossing being considered. One such list filtered for user worked crossings with telephones, generated on 17 November 2008 for Sewage Works Lane contained only one 'education' option for risk mitigation. This was described as high-cost (£100,000+), because it comprised a campaign at national level involving television, radio and press, rather than simple engagement with the user(s) at an individual crossing or any form of local education.
- 107 Witness evidence suggests that within Network Rail, there were two different interpretations of the actions necessary once a trigger risk assessment had been completed, with one interpretation being that it was always necessary to write to authorised users (one low cost method of 'education', which could be seen as a risk mitigation measure) and another that it was not required if the ORCC did not consider that it would be beneficial.
- 108 A footnote in Appendix A to Procedure 5-22 of the Operations Manual stated that:
- 'Following the 'trigger' risk assessment, risk reduction measures shall be considered where it is possible to identify potential factors increasing the risk of misuse, and there are potential solutions to address those risks. These shall be taken forward for implementation where they can be demonstrated to be effective and can be considered to be reasonably practicable (ie the spend to achieve them is not grossly disproportionate to the benefits expected). Risk reduction and mitigation actions considered shall include engineering, enforcement, education and enablement, and closure.'

¹² A footnote in Appendix A to Procedure 5.22 of the Operations Manual states that 'where possible, highway authorities, the BTP, Civil Police forces and road rail partnership groups shall be involved in the review of (trigger) risk assessments, findings and recommended actions...'. No mention is made of authorised users at user worked crossings.

- 109 One school of thought within Network Rail was that a letter to authorised users would always be reasonably practicable because of the very small cost involved. The use of the word 'shall' in the footnote quoted at paragraph 108 was considered to make this a mandatory requirement. However, neither the procedure nor the footnote explicitly stated that there was a minimum requirement to write to authorised users after trigger risk assessments. Network Rail's Anglia Route did not consider writing such a letter to be a mandatory requirement. The RAIB considers that it was possible to interpret the requirements in a way that permitted the ORCC to conclude that engagement with the authorised user was not always necessary before, during or after a trigger risk assessment. As shown in table 4, it did not happen after 2005.
- 110 It would, however, have been good practice to write to authorised users about near-miss incidents to remind them of their responsibilities. There is evidence of correspondence being sent following near-miss incidents in the years leading up to 2005. The last occasion that such a letter was sent was after the incident that occurred in June 2005 (see table 4). The letter described the incident, reminded the authorised user of the correct method for using the crossing and the importance of using that method and enclosed a copy of Network Rail's crossing track code and a copy of an item from the BBC's website about an accident on a user worked crossing.
- 111 The RAIB has considered why this practice was not followed by Network Rail ORCCs after 2005.
- 112 In the period 2006 to 2009, the Operational Risk team in Network Rail's Anglia Route had been falling behind with its processing of level crossing risk data (this process is described in more detail from paragraph 128 onwards). This had not come to light because from 2007 onwards the ORA had been declaring that the team was fully compliant with the requirements of the Operations Manual.
- 113 In July 2009, following concerns expressed by a member of the Anglia Operational Risk team, Network Rail investigated the activities of that team. The investigation identified that although site visit forms for nine level crossings had been completed, no site visits had been made to those crossings. There was a backlog of up to 300 data collection forms that had not been entered onto Network Rail's level crossings database. As the details from the forms had not been entered onto the database, the associated crossings had not been subject to risk assessment at the mandated frequencies. Although Sewage Works Lane UWC was not one of the crossings affected by this discovery, the build-up of work may be one explanation of why only limited attention was being given to reviewing the findings from those risk assessments that were completed during this period, and taking action such as communicating with authorised users. However, Network Rail's investigation did not highlight insufficient resources or high workload as underlying factors.
- 114 As a result of the investigation, a number of employees were replaced.
- 115 A new ORA was appointed to lead the team in October 2009. The ORA set about the task of dealing with the backlog of risk assessment data from level crossings. Previous data that had not been processed was deemed invalid and the crossings had to be assessed again.

- 116 The new ORA formulated an action plan which required an estimated 60 level crossing risk assessments to be completed each month. During this period, the number of ORCCs available to undertake those risk assessments varied between one and three, although the ORA also undertook risk assessments to help to reduce the backlog.
- 117 The ORCCs said that the size of their task was increased by data errors, discrepancies and the generally poor quality of the information supplied by the MOMs. The ORA focused the team's activities on data entry and compliance with level crossing management procedures. The ORCCs said that this left little time for a detailed evaluation of the data gathered for the risk assessment of each crossing and consideration of any form of risk mitigation. The data processing is explained in more detail in paragraphs 131 to 162.
- 118 Within the ORA's new team most of the ORCCs had limited experience (paragraph 25). The two ORCCs responsible for Sewage Works Lane UWC in 2009 and 2010 were heavily involved in dealing with the backlog of level crossing data input and risk assessment at the same time as they were gaining experience in the role.
- 119 The legacy from the problems associated with Anglia's Operational Risk team therefore led to a new and relatively inexperienced team taking responsibility for level crossing risk management from the middle of 2009. However, there is evidence that the ORA who took charge of the section in 2009 put in place a plan to address the backlog of level crossing risk assessments and to achieve compliance with Network Rail's level crossing management procedures.
- 120 The workload of the new team and the number of vacancies being carried at different times (paragraph 25), the relative inexperience of the team members and ambiguity in the procedures (paragraph 107) were all probable reasons why there was no engagement between Network Rail and Anglian Water over the misuse and near-miss history at Sewage Works Lane UWC in the year leading up to the accident.
- 121 The RAIB report into safety at user worked crossings (13/2009) identified that the involvement of the authorised user (or other appropriate persons) in the preparation of a risk assessment for a UWC would be valuable in informing Network Rail of the control measures needed at the crossing, but only took place if the crossing assessment by Network Rail showed it to be a higher risk.
- 122 The report made a recommendation to Network Rail that the company should invite the authorised user or others (such as persons having business on the land) to participate in the preparation of comprehensive site specific risk assessments for UWCs in all cases. The intention of this recommendation was that all factors affecting the use of the crossing should be considered when risk assessments are carried out and that this should be done at all crossings, instead of just at those which have been assessed as higher risk. Network Rail's response was that this already occurs for higher risk crossings. The standard letter to known authorised users is to be amended so as to invite those authorised users of all level crossings to contribute to the risk assessment process, further to the current request for the provision of user data. Network Rail noted that with about 2500 UWCs (many with multiple authorised users), co-ordinating their involvement will be challenging and that with the significant majority of UWCs recorded through ALCRM being comparatively low risk, it may not be considered reasonably practicable to involve the user(s) in all cases.

123 Research undertaken by RSSB, 'User behaviour at user worked crossings' (T269) showed that involvement in, or knowledge of, an accident or a near-miss at a crossing has a significant impact on user behaviour. The evidence showed that where communication had taken place between Network Rail and the authorised user in 2004-2005, the number of misuse and near-miss incidents had decreased. Had Anglian Water been aware of the extent of non-compliance with the required method of use at the crossing, it might have taken action which would have prevented the accident.

Network Rail's compliance with its own procedures for routine risk assessments at level crossings

124 It is probable that Network Rail did not comply with its own procedures for engaging with authorised users in the routine risk assessment undertaken in June 2007 at Sewage Works Lane UWC. This was an underlying factor in the accident.

125 Network Rail's Operations Manual (Procedure 5-22) defined the requirements for writing to authorised users at user worked crossings. The ORCC was required to write to authorised users 2-3 months before routine risk assessments to remind them of the correct method of using the crossing, prompt correspondence on any issues they had with the crossing and ask them about their usage of the crossing. The standard letter invited authorised users to participate in the forthcoming risk assessment at the crossing. In the period between 2005 and 2009, the triennial risk assessment of Sewage Works Lane UWC was undertaken on 28 June 2007. Network Rail was unable to provide evidence that an invitation had been sent to Anglian Water to participate in the risk assessment.

126 The reason why this did not happen is probably linked to the issue described in paragraph 112, above.

127 This meant that another opportunity for engagement with Anglian Water over the history of near-miss and misuse incidents was missed.

The risk management process at Sewage Works Lane UWC

128 Although there was a significant history of misuse and near-miss incidents at Sewage Works Lane UWC, this was not taken into account when the crossing was subject to risk assessment. As a result, insufficient weight was given to the need to mitigate risk at the crossing and the misuse continued.

129 There were two principal components of the risk management process (figure 11):

- data gathering about the crossing; and
- processing of the data gathered to provide an indication of the level of risk at the crossing and consideration of the outcome.

Data gathering process

130 The gathering of data as an input to the risk assessment process for Sewage Works Lane UWC was characterised by errors and omissions in the information recorded and the predictable risk arising from the long waiting times for road vehicles at the crossing was not taken into account. This was an underlying factor in the accident on 17 August 2010.

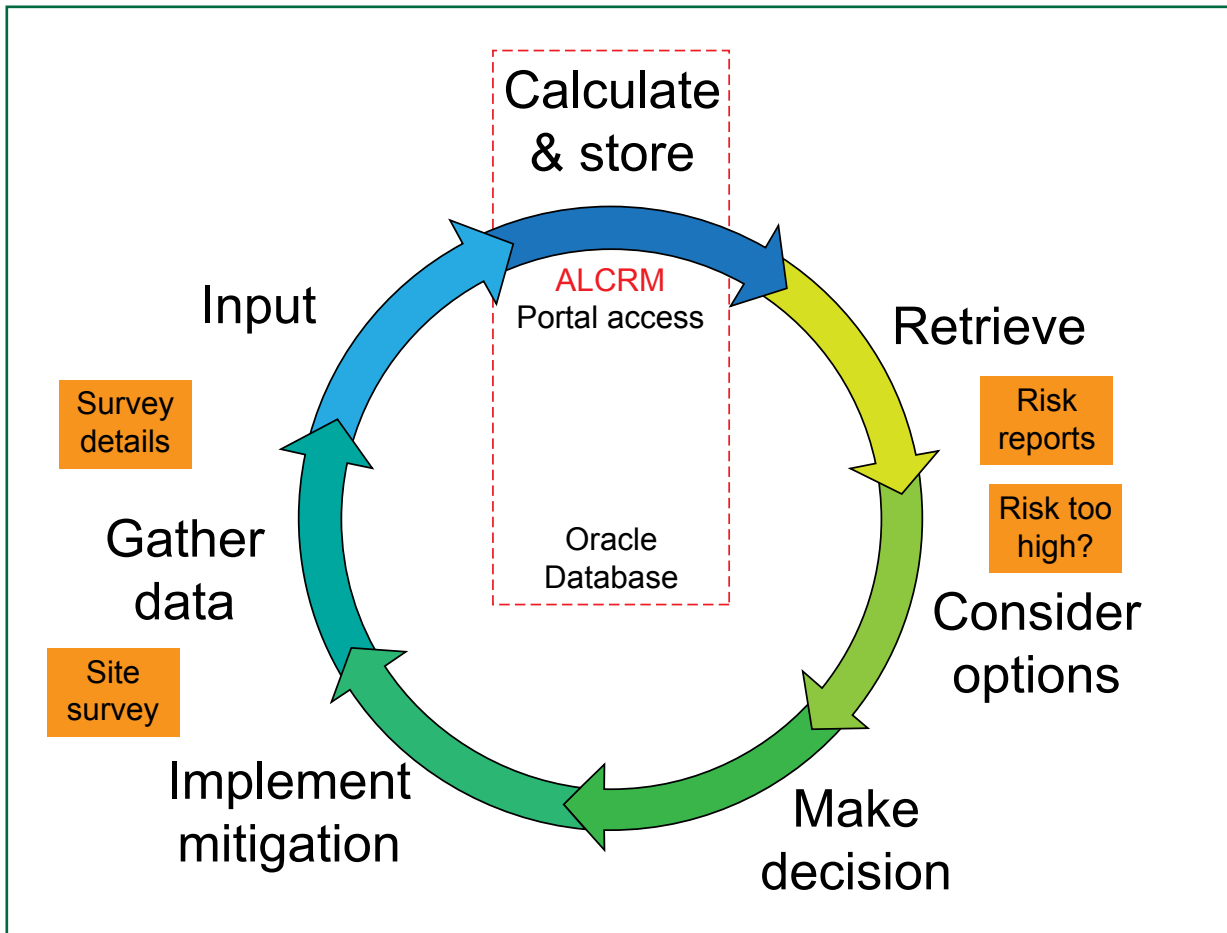

Figure 11: Diagram showing the business process in risk assessment of level crossings.

- 131 The gathering of data as an input to the risk assessment process was undertaken by staff for whom it was one of many tasks. At Sewage Works Lane UWC, a MOM based at Colchester undertook data gathering. Such an exercise would be routinely undertaken every three years, unless a near-miss incident occurred or there were significant changes in usage of the crossing.
- 132 The need for an assessment to be undertaken was identified by the Anglia route-based ORCC who had responsibility for that crossing and passed to the relevant Local Operations Manager, who would nominate a MOM to undertake data gathering at the site. As well as undertaking data gathering for level crossing risk assessments, MOMs' responsibilities include responding to operational issues such as points failures and accidents or incidents within a defined geographical area. When an ORCC requests data gathering to be carried out, it must be completed within five days of the request, including the transmission of all data to the ORCC. Failure to complete all parts of the process results in the crossing having to be reassessed.

- 133 The MOM records basic information on site such as sighting distances, type and condition of crossing infrastructure and use of land adjacent to the crossing (eg farm, industrial, school, etc.) and takes photographs. The MOM is required to record whether there have been near-miss or misuse incidents at the crossing. The MOM also undertakes a census of crossing usage and should call the signaller to ascertain the frequency of use and details of crossing misuse incidents. The preferred type of census for UWCs is a 'quick' census, which Network Rail standards state should be:
- 30 minutes in duration; and
 - carried out between 09:30 hrs and 16:30 hrs Monday to Friday.
- 134 If crossing use is very low an estimated census is allowed with guidance given on speaking to the local users to gain more useful intelligence.
- 135 For Sewage Works Lane UWC, the RAIB's investigation showed that data gathering visits were carried out in accordance with standards and the training given. A review of the crossing assessments from 1998 to 2010 shows that the level of LGV traffic estimated on the forms was either 0 or 1 vehicle per week (all forms contained an estimate of usage as well as a figure for actual usage if any vehicles were seen using the crossing while the census was being carried out). The RAIB's investigation has shown that a more accurate figure was between 4 and 12 vehicles per week. However, in 2008, a LGV did cross while the census was being taken, which meant that the overall estimate of crossing usage applied in the subsequent risk assessment increased significantly. This is discussed further in paragraph 152.
- 136 At no stage in the period 1998 to 2010 did a MOM or ORCC check other sources such as the log maintained by Liverpool Street IECC (paragraph 59) to establish more accurate data on crossing usage. Network Rail considered that the reason for this was that the MOM believed that the ORCCs would perform the check and that the ORCCs believed that all instances of misuse were being reported by signallers to the route control office, who would log the incident, leading to details being input to SMIS. However, even if the IECC log had been scrutinised, the actual level of misuse would not have been revealed for the reasons described in paragraph 59.
- 137 In the period between 2005 and 2009 data gathering for risk assessments was undertaken at Sewage Works Lane UWC on three occasions (a routine risk assessment in 2007 and trigger risk assessments in 2008 and 2009). The RAIB has reviewed the data gathered for these risk assessments and noted inaccuracies in the information recorded and inconsistencies between the three data gathering exercises. Data gathering forms were sometimes not completed and in other cases data had clearly been copied from previous forms.
- 138 The last risk assessment of Sewage Works Lane UWC before the accident took place on 9 September 2009. This was a 'trigger' risk assessment following a near-miss incident on 18 August 2009. The data gathering part of the exercise was undertaken by a MOM who had never been to this crossing or to the adjacent crossing (Shalfords UWC), before. The MOM made an estimate of crossing usage and recorded that they had undertaken an interview with a crossing user who said that the crossing was used "two or three times to gain access to the house". Sewage Works Lane UWC does not provide access to any houses.

- 139 Apart from this error, the data gathering exercise was characterised by other missing and contradictory data:
- the MOM did not understand what was required on one of the forms used for the purposes of data gathering and did not complete it;
 - he recorded in one part of the form that operational disruption took place because users did not use the telephone but in another part of the form recorded that the telephone was always used;
 - traction power for trains was incorrectly shown as being supplied from an overhead line, whereas the line is not electrified;
 - traverse time for vehicles made no reference to LGVs; and
 - he was not aware that LGVs used the crossing.
- 140 Based upon the discrepancies on the form and witness evidence the RAIB considers that it is possible that:
- the MOM's assessment on 9 September 2009 was completed at Shalfords UWC (which does provide access to a house) rather than at Sewage Works Lane UWC; or
 - the form used was based on details contained on a form that had been prepared for another crossing, and that some of the original details were not changed.
- 141 MOMs are trained in data collection before being formally appointed to the job. The MOM who undertook the data gathering at Sewage Works Lane UWC in September 2009 had been trained for the task, although the practical element of his training was undertaken at a different type of level crossing. The MOM reported that the training and assessments did not cover all types of level crossing.
- 142 At the time that he received his training, the MOM considered it to be satisfactory and believed that he was competent to complete the risk assessments because the trainers had considered him to be competent.
- 143 Witness evidence indicates that the MOMs on the Anglia Route who had been trained in Network Rail's risk assessment process considered it to be a tick-sheet exercise. They also considered that there was not enough emphasis on the importance of the data gathering task within the training module, and that some MOMs did not enjoy the task of level crossing data gathering as they did not have the time to do it as well as their other duties.
- 144 The poor quality of the intelligence gathered on site was one of the reasons why the underlying risk at the crossing was not identified. Better data gathering including discussions with the signallers (which was a mandatory requirement within the Operations Manual) might have highlighted the nature of traffic using the crossing and the higher level of usage. Taken in conjunction with the history of near-misses and misuse, it is possible that the underlying risk at Sewage Works Lane UWC would have been more evident and action taken to address the risk if better intelligence had been gathered on site.

Data evaluation

- 145 **The amount of time devoted to analysing the results from the risk assessment for Sewage Works Lane UWC and considering possible risk mitigation measures was limited. This was an underlying factor in the accident.**
- 146 The evaluation and assessment of the data gathered at Sewage Works Lane UWC was undertaken by an ORCC using intelligence about the crossing provided by the MOM, data gathered in previous exercises as a comparator and scrutiny of maps. In Network Rail's Anglia Route, the inputting and evaluation process was not always completed by the ORCC responsible for the risk management of the crossing in question, but was undertaken by another competent ORCC within the Operational Risk team. However, the use of different ORCCs to risk assess individual crossings meant that it was not possible for one ORCC to acquire a more in-depth understanding of the characteristics of each crossing.
- 147 The data collected by the MOM was input into the ALCRM, a full explanation of which is provided in appendix D. The ALCRM provides an estimate of risk and classifies it in the following ways:
- Individual risk of fatality (identified by a letter A (high) to M (low)), which is the fatality risk to an individual using the crossing on a frequent basis (500 times per year); and
 - Collective risk (identified by a number 1 (high) to 13 (low)), which is the risk to all individuals involved, including users, train crew, passengers and pedestrians.
- 148 Factors which can influence the predicted risk include the number of trains, the number and type of crossing users, poor sighting and environmental factors such as glare from the sun at certain times of day.
- 149 The Operations Manual (procedure 5-24) outlined the process to be followed when the level crossing data has been evaluated by the ALCRM. This process is intended to identify any reasonably practicable measures to mitigate the identified risk. Post-ALCRM processing is informed by a computerised system known as the Level Crossing Risk Management Toolkit. This provides a listing of options for consideration and indicative costs for each one. The list can be filtered to include only those measures that are relevant to specific crossing types.
- 150 The principal factors that should be considered when assessing the safety benefits of a proposal are the financial impact and longevity of risk reduction against the mitigation measures proposed. Other factors that are mandated for consideration as part of this process are:
- previous occurrences and accidents;
 - level of misuse;
 - previous near-misses;
 - the potential consequences; and
 - risk reduction and benefits.

- 151 A separate cost benefit tool was available which could be used to evaluate the costs and benefits of safety improvements at a level crossing site. In the five years leading up to the accident, ORCCs did not use this tool because no risk control measures were identified for assessment.
- 152 The data gathered at Sewage Works Lane UWC in 2007 (routine risk assessment) and 2008 (trigger risk assessment) were used as input to a risk assessment in accordance with elements of the process described above. Noteworthy features of these risk assessments were:
- In June 2007, no vehicle usage was included in the assessment, probably because no vehicle usage was recorded on the census undertaken by the MOM. However, the MOM had estimated a level of vehicle usage (LGVs weekly and other road vehicles once or twice daily). The risk at the crossing was classified in the ALCRM assessment as D6 (paragraph 147). This ranking was consistent with that obtained from risk assessments at many user worked crossings, where high levels of individual risk are not unusual because there is a single 'most exposed user' (typically, someone living adjacent to the crossing) who uses the crossing frequently. The key risk drivers at the crossing were identified as low sighting time, gates open, large numbers of users (the basis for this is unknown because there were not many users) and user misuse. The reference to low sighting times is curious because telephones were provided for road vehicle drivers and the sighting times were, in any case, acceptable for pedestrians. No risk mitigation measures were identified and no further action was taken after the assessment because of the reasons previously outlined with regards to the available resources and heavy workload.
 - In November 2008, a trigger risk assessment was undertaken following the two near-miss incidents that had occurred in July 2008. On this occasion, one car and one LGV were seen during the census undertaken by the MOM, as a result of which vehicle usage was assessed as 54 vehicles per day. This is because ALCRM multiplies the figures recorded in the 30-minute census by 27 to obtain a daily estimate of usage. The MOM had also estimated usage, which was the same as that recorded in June 2007 (one LGV per week and one to two cars per day). The increased vehicle usage arising from the census resulted in the risk at the crossing being classified in the ALCRM assessment as C3. The key risk drivers at the crossing were the same as those identified in the previous risk assessment. On this occasion, the level crossing toolkit was used to review possible risk mitigation measures at the crossing and all were endorsed 'not applicable', thus completing the risk assessment. No further action was taken after the assessment, even though Network Rail's own procedures mandated that a further visit should have been made to the crossing because of the collective risk score of 3 that had been obtained.

153 During 2007 and 2008, there were two other site visits recorded as being made to Sewage Works Lane UWC by Network Rail staff in relation to risk at the crossing:

- In accordance with Network Rail's Operations Manual, a 'post-ALCRM assessment site visit' form was completed showing that the ORCC and ORA had visited Sewage Works Lane UWC on 15 November 2007. There was no requirement for a trigger risk assessment to be undertaken following the near-miss in October 2007 (table 4) because a routine risk assessment had been completed within the previous six months. The form shows that the only mitigation that the ORCC had identified and required was to write to authorised users about the crossing procedure. Anglian Water had no record of receiving a letter from Network Rail.
- Another 'post-ALCRM assessment site visit' form was completed showing that a different ORCC had visited Sewage Works Lane UWC on 10 June 2008. The form records that there was a history of users not calling back and that users had been sent a safety guide. Anglian Water managers have stated that they had no recollection of receiving such a guide. The same form also records 'suggest no further mitigation required'. The RAIB has been unable to establish why this visit was made as it was not mandated by any procedure and was not undertaken in response to any incidents of misuse or a near-miss.

154 The risk assessment undertaken in 2009 was based on inaccurate data (paragraphs 138 to 140)¹³. The reliability of the data is therefore in doubt. The details recorded are that one car was seen crossing during the census and that was used as the basis for the ALCRM assessment. Key risk drivers were identified as 'gates left open' and 'user misuse'. The ORCC did not propose any initiatives on user education or upgrading the crossing following the risk assessment of 2009.

155 Network Rail's Operations Manual states that the ALCRM risk score should not be the single driving factor and historical misuse and near-miss incidents combined with potential for accidents should also be borne in mind and combined with the ORCC's expertise and local knowledge. However, there was a tendency in Anglia Route for the ORCCs to view the output from ALCRM as a conclusion to the risk assessment and give little, if any, consideration to risk mitigation measures.

156 This tendency had been previously seen in other Network Rail routes and was identified in the RAIB report (16/2010) into the fatal accident at Halkirk Level Crossing and in the safety bulletin (7/2010) issued after a fatal incident at Penrhyndeudraeth. An underlying theme in both investigations was that staff who apply the level crossing risk management process should have sufficient guidance on how to assess the risk from factors not included in the ALCRM assessment, including taking into account local factors such as the previous incident and accident history.

¹³ Some of the data gathered for the assessment undertaken in September 2009 was challenged by the ORCC and amended for the purposes of the risk assessment, but the challenges related to elements that could easily be identified remotely by the use of mapping tools such as the geographical context of the crossing or sighting distances (using previous forms for the purposes of comparison). The ORCCs' own lack of detailed knowledge of every crossing within their portfolio meant that they were not in a position to challenge some elements of the data provided.

- 157 Network Rail had not classified Sewage Works Lane UWC as a particularly problematic location between 2005 and 2010. The ORAs and ORCCs believed that responsibility for crossing misuse resided with the crossing users. They did not consider that the crossing itself might have contributed to the crossing's misuse history. For that reason, the ORCC and ORA believed risk mitigation measures focused on the crossing itself would be ineffective.
- 158 The last time that risk mitigation measures focused on the infrastructure had been considered was in 2003. At that time, consideration had been given to the installation of 'novel' warning devices at Sewage Works Lane UWC, which had not, at that stage, been fully developed. Network Rail's crossing inspector responsible for assessing the risk at the crossing in 2003 was aware of the delays to road users through his discussions with Anglian Water and feedback from his own level crossing inspections (data gathering was not undertaken by MOMs at this time). In Spring 2004, construction work started at the sewage works, which resulted in increased use of the crossing by heavy vehicle traffic, continuing until the end of the year. Network Rail introduced local arrangements (a crossing keeper) for the period of the construction works. Miniature stop lights were considered, but deemed to be not reasonably practicable at an estimated cost of £500,000, irrespective of whether they were provided for the duration of the works or on a permanent basis. The novel warning devices referred to at the time of the 2003 assessment never came to fruition.

Network Rail's overall knowledge of the risk at Sewage Works Lane UWC

159 No single person or team in Network Rail had a complete understanding of the risk at Sewage Works Lane UWC. This was an underlying factor in the accident.

- 160 Taking the data gathering and risk evaluation process overall (paragraphs 130 to 158), the evidence obtained through the investigation shows that from 2005 onwards there was a disconnection between the acquisition of crossing data and its use. This meant that nobody within Network Rail had a complete understanding of the operating environment at the crossing and the associated risk. The actual level of misuse was running at a level that was 200-300 times greater per year than Network Rail's own data was showing (paragraphs 58 and 59 and table 4). ORCCs were unaware of the long waiting times being experienced by crossing users (paragraph 53) and of the reason for the delays (the line was not track circuited and the signaller could not know where trains were with any degree of reliability). They could not therefore associate this information with the crossing's near-miss and misuse history.
- 161 The fact that the risk classification changed from D6 in 2007 to C3 in 2008 and then to C6 in 2009 and that this was not followed up by the ORCC in 2008 and 2009 is indicative of the lack of attention that was being given to the output from risk assessments. The changes in classification were almost certainly the result of the different usage data that was input during that time (paragraph 152).

162 The RAIB considers that if the critical items of data about the crossing had been known to one individual who was responsible for data gathering and data processing, and had a good knowledge of the crossing itself, it is possible that action would have been taken to mitigate the risk. As a minimum, it is likely that there would have been some engagement between Network Rail and Anglian Water, which might have alerted the latter to the high level of non-compliance among its staff and contractors with the requirement to use the telephone before crossing at Sewage Works Lane UWC. Anglian Water might have taken action to enforce compliance, as it did after the accident (paragraphs 78 and 202).

The ability of ALCRM to highlight the underlying risk at the crossing

163 Paragraphs 130-162 have highlighted issues relating to data gathering and evaluation at Sewage Works Lane UWC. The data that was gathered at the crossing contained inaccuracies (paragraphs 138 and 139) and there was a tendency within the Anglia Operational Risk team to view the output from the ALCRM as a conclusion to the risk assessment (paragraph 155), rather than as the basis for detailed consideration of risk mitigation measures.

164 However, even if the data had been gathered and evaluated accurately, the ALCRM was not configured to identify the underlying risk at the crossing. After the accident, Network Rail corrected the input data to reflect actual vehicle usage at the crossing which resulted in a risk classification of C7. This can be compared with risk classifications of D6 in 2007, C3 in 2008 and C6 in 2009 (paragraph 161). The 2010 classification based on accurate data actually indicated a lower risk than that which had been estimated in 2009 (before the accident). This was for two reasons:

- The 2009 assessment had been based on a more frequent train service than was actually timetabled. The output from the ALCRM is particularly sensitive to the number of trains using a crossing.
- The ALCRM does not reflect a crossing's accident, incident and near-miss history in the risk classification which constitutes its output (paragraph 147). The ALCRM uses data input by the ORCC on instances of gates being left open and how the phones are used to identify whether the level of misuse is above the expected norm (a base level of misuse is assumed within the model). If so, misuse or gates left open are shown as risk drivers, but no modification is made to the risk classification. There is also a question relating to whether there has been misuse of the crossing. The person inputting the data can answer 'yes' or 'no' to this question and provide additional text information if they so wish. However, answering 'yes' has no impact on the crossing's risk classification. Network Rail has indicated that these questions were included in the model so that risk assessors could use the information as one of the cues to identify that user misuse had been, or was predicted to be, an issue and to give consideration to the risk arising and measures needed to address the risk.

165 The inability of the ALCRM to ascribe any numerical risk value to the underlying factor of misuse at a crossing highlights the need for an individual to have a comprehensive understanding of all the risk factors at a crossing when evaluating the output from ALCRM assessments.

Crashworthiness

166 Although the train involved in the accident was not designed to withstand a collision with a large goods vehicle, the majority of the injuries were caused by the interaction of passengers and tables rather than by structural deformation of the vehicles themselves. The design of the tables may have contributed to the severity of the consequences of this accident.

167 The Class 156 unit and the tanker involved in the accident were examined to:

- determine how the train performed;
- establish any physical evidence of inherent defect or fatigue within the framework of the train and its interior furnishings;
- understand the damage caused by the impact; and
- corroborate witness evidence for the purpose of understanding the origin and cause of the injuries sustained by the passengers.

168 Appendix E contains background information on applicable standards relating to *crashworthiness*.

169 In the accident at Sewage Works Lane UWC, the bottom of the tanker barrel was 1.2 metres above the road and at approximately the same height as the floor on the Class 156 unit. As a result, the tanker came halfway up the height of the train body as shown in figure 12 (this type of collision is known as an 'over-riding collision' as the point of impact is above the level at which the energy absorbing devices are normally located on a railway vehicle).

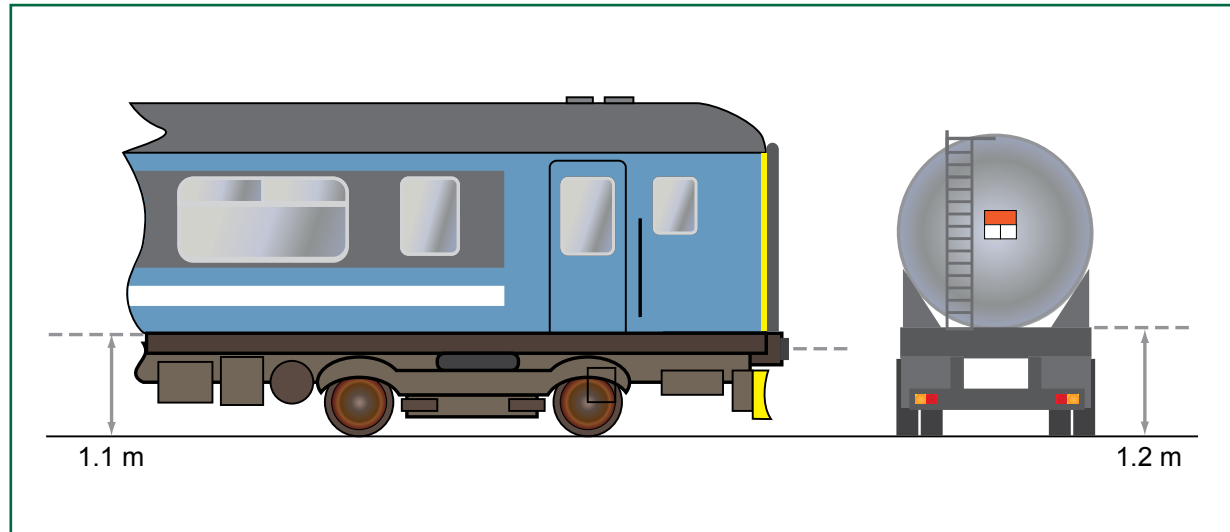

Figure 12: Diagram showing the relative height of Class 156 and sewage tanker

170 From the amount of deformation of the train, the RAIB has estimated that the train absorbed approximately 0.5 MJ of energy. The ability to absorb 0.5 MJ of energy in an over-riding collision was the standard requirement applicable to modern railway vehicles up to December 2010.

171 The leading and rear vehicle interiors were examined for evidence of inherent defects which could have affected the performance of the vehicle during the accident. In particular, the inspection concentrated on the behaviour of the seats and tables as witness evidence suggested that the tables had contributed to the nature of the injuries.

172 None of the six rearward facing seats which were occupied showed permanent deformation as a consequence of the accident. The moderate level of deceleration (see appendix E) seen by the interior combined with the single occupancy of all double seats means that the lack of damage to the seats in this accident is unsurprising.

173 Three tables on the leading vehicle and six tables on the trailing vehicle were found to be damaged. A typical example of deformation is shown in figure 13.



Figure 13: Typical example of table deformation



Figure 14: Typical example of table deflection

174 The tables deflected in the direction of travel, rotating around one of the corners of the table in contact with the body side. In two cases, the rotation of the tables was only arrested as the front table leg contacted the seat opposite (an example is shown at figure 14). The table top in these cases would have severely intruded into the survival space of the passenger on the seat opposite. Fortunately none of these seats was occupied.

175 In several cases, the front leg became fully or partly detached from the table top as shown in figure 14. The tapping plate into which the top of the leg was bolted was pulled through the plywood revealing sharp edges. This is undesirable and would not meet the requirements of current interior standards which require the table to fail in a manner which is not likely to cause injury through secondary impacts.

176 The front leg connection to the floor exhibited two types of deformation as shown in figures 15 and 16. In seven cases, the table leg bent and deformed plastically without material failure. In two cases, the table leg failed at the weld to the base plate. This meant that the table leg provided little or no energy absorption due to the inadequate weld strength.



Figures 15 and 16: Damaged legs at base of interior tables within the vehicles

177 Overall, the performance of the tables resulted in the potential for survival space to be compromised and the severity of the injuries to be increased.

Previous occurrences of a similar character

Risk associated with level crossings

178 Of the 6,452 crossings on Network Rail infrastructure, 2,515 (39%) are user worked crossings, of which 1,614 (25%) are equipped with telephones, the type of crossing that was provided at Sewage Works Lane.

179 In 2010, RSSB produced a road-rail interface special topic report¹⁴. This showed that around 50% of the risk from trains colliding with road vehicles at crossings occurs at user worked crossings, with around 25% of the risk at user worked crossings with telephones. While this might appear to suggest that the risk at user worked crossings is proportional to their number, it should be borne in mind that there is a low level of vehicle usage at these crossings in comparison with many other types of crossing because they are mainly located on private roads.

¹⁴ Available on the RSSB website: www.rssb.co.uk/SiteCollectionDocuments/pdf/reports/road-rail_interface_str_full.pdf.

180 Figures 17 and 18 below are extracts from the special topic report and show the number of collisions that have occurred at different types of crossing in a ten year period and the risk arising from those collisions. The figures show that user worked crossings with telephones have the third highest number of collisions when compared with all other types of crossing and contribute the second highest level of overall risk, although they drop in rank to 7th when the figures are normalised by the number of such crossings on the network. Figure 18 also shows that the normalised risk at UWCs equipped with miniature stop (warning) lights is approximately six times higher than that at UWCs equipped with telephones. Miniature stop lights are normally provided on crossings with a higher level of underlying risk, often arising from much higher usage than applies at most UWCs. It should not be the case that risk will increase if miniature stop lights are provided at a crossing that has hitherto only been equipped with telephones. This has now been recognised by the railway industry (see paragraph 184 and its associated footnote).

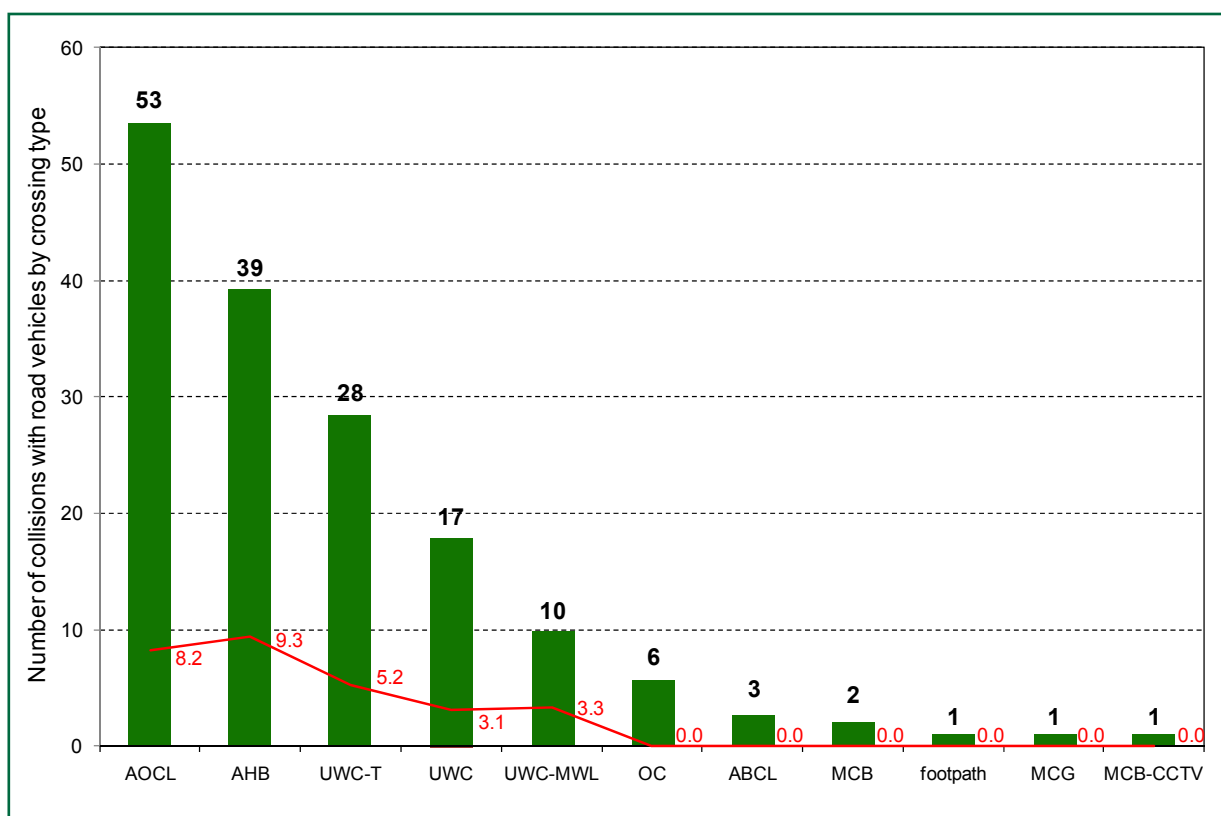

Figure 17: Collisions at level crossings¹⁵ by crossing type over ten years (reproduced by courtesy of RSSB)

¹⁵ Other types of crossing referred to are: Automatic Open Crossings, Locally Monitored (AOCL), Automatic Half Barrier Crossings (AHB), Open Crossings (OC), Automatic Barrier Crossings Locally Monitored (ABCL), Manually Controlled Barrier Crossings (MCB), Manually Controlled Gated Crossings (MCG) and Manually Controlled Barrier Crossings with CCTV (MCB-CCTV).

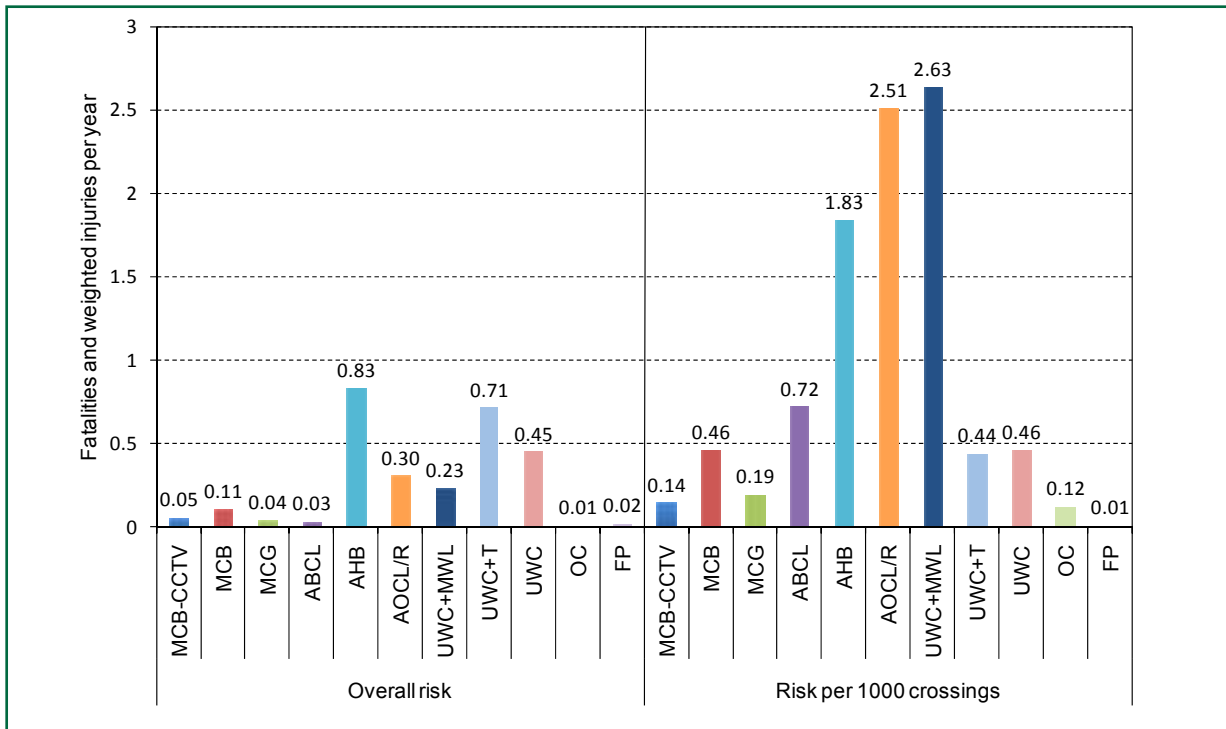

Figure 18: Risk from trains striking road vehicles, based on data contained in RSSB's Safety Risk Model, Version 6 (reproduced courtesy of RSSB)

181 While the railway industry has made significant progress in reducing risk in a number of categories in the last ten years, risk from level crossing misuse (by members of the public) has seen a smaller reduction in risk in the same period. This is illustrated in figure 19 below, reproduced from the RSSB's Annual Safety Performance Report 2009/2010¹⁶.

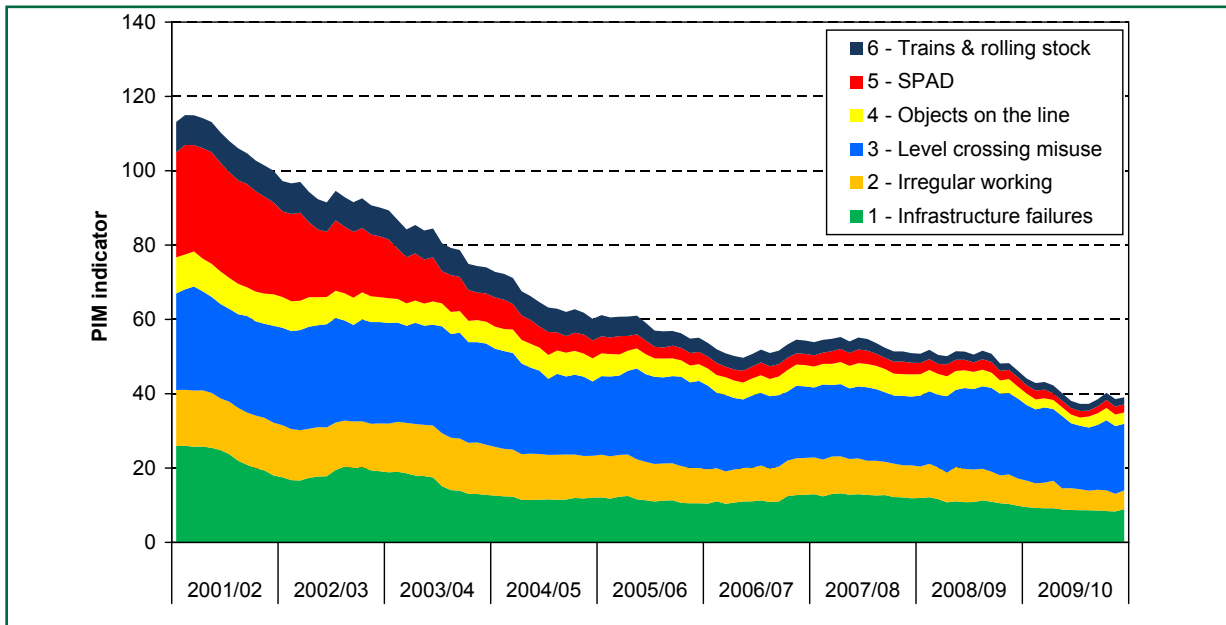

Figure 19: Trends in train accident risk 2001-2010¹⁷ (reproduced by courtesy of RSSB)

¹⁶ Available at the RSSB website: www.rssb.co.uk/sitecollectiondocuments/pdf/reports/ASPR_2009_10_Full_Report.pdf.

¹⁷ The acronym 'PIM' on the 'y' axis refers to RSSB's Precursor Indicator Model, which takes account of the underlying risk from train accidents that are infrequently experienced, but could still occur. Not all level crossing risk arises from train accidents.

Other relevant accidents

182 Collisions between trains and heavier vehicles (above the weight of a car) at UWCs have occurred on a number of occasions in recent years:

- On 2 July 2001, a train travelling from Gillingham to London Waterloo collided with an articulated lorry which was crossing at Tisbury Quarry UWC. Although the crossing was equipped with miniature stop lights, the driver of the articulated lorry was required to telephone the signaller for permission to cross because he was driving a large, slow moving vehicle. The driver of the articulated lorry did not telephone the signaller for permission to cross.
- On 7 July 2003, a train travelling from Hereford to London Paddington collided with a minibus at Pool's UWC, Evesham. The crossing was equipped with a telephone to enable a road user to call the signaller before crossing, but it was not used. As a result of the collision, three occupants of the minibus were fatally injured and one seriously injured. One passenger on board the train received minor injuries.
- On 19 October 2005, a train travelling between Littleport and Downham Market collided with a tractor hauling a trailer over Black Horse Drove UWC (RAIB Report 12/2006). The immediate cause of the fatal accident was that the tractor driver started to cross the railway despite the miniature stop light being red and with a train approaching at speed. One recommendation relevant to the accident at Sewage Works Lane UWC was made:

‘Infrastructure owners where they do not already do so should implement a system to regularly write to all authorised users of user worked crossings, regardless of type, to draw their attention to the safe method of use of these crossings.’

Network Rail accepted the recommendation and included relevant provisions in the Operations Manual, and the National Level Crossing Safety Campaign and booklet. Network Rail also undertook major publicity campaigns to raise road users' awareness of risk at level crossings and the safe method of operation (including operation of user worked crossings).

- On 2 August 2007, a train struck a tractor on a user worked crossing close to the disused station at Limavady Junction between Coleraine and Londonderry in Northern Ireland, fatally injuring the tractor driver. The RAIB's investigation (report 10/2008) identified a number of reasons why the tractor driver may not have seen the approaching train.
- On 31 January 2011, a train travelling from Manchester Piccadilly to Milford Haven collided at 65 mph (105 km/h) with a tractor and trailer at Morfa Main UWC between Pembrey & Burry Port and Kidwelly. The train was not derailed as a result of the impact, nor were any injuries reported by the train crew or the twenty passengers. The UWC is equipped with a telephone which the drivers of road vehicles are required to use to get the signaller's permission to cross. No request had been made to the signaller for use of the crossing.

183 The RAIB has investigated two other accidents involving cars on level crossings which have some immediate relevance to the accident at Sewage Works Lane UWC (these have been briefly referred to in paragraph 156).

- 184 On 2 September 2009 a single locomotive running along the Cambrian Coast line, collided with a car at a user worked crossing at Penrhyndeudraeth in North Wales. The car driver did not use the telephone to contact the signaller to ask if it was safe to cross and was fatally injured in the collision. RAIB bulletin 07/2010, published on 15 June 2010, observed that the assumptions on telephone usage, train speed and sighting distance at this crossing which were entered into the ALCRM prior to this accident did not reflect the situation encountered by users at the crossing. Following the accident, the ALCRM was used to evaluate the costs and benefits of installing miniature stop lights at this crossing. The output from the ALCRM showed that the risk would increase (paragraph 180). The RAIB's bulletin contained learning points regarding the ALCRM and the counter-intuitive and apparently erroneous results it could produce¹⁸. It illustrated the importance of level crossing risk assessors applying expert judgement when interpreting risk data generated by ALCRM and the need for Network Rail to provide training and guidance to relevant staff (MOMs and ORCCs) on how this should be done.
- 185 At 14:09 hours on 29 September 2009, the 10:38 hrs train from Inverness to Wick struck a car on a level crossing at Halkirk, Caithness. The three occupants were fatally injured. An underlying factor was that Network Rail did not fully understand the risk at Halkirk level crossing because the crossing's previous incident and accident record was not taken into account in determining whether risk reduction measures were reasonably practicable. More costly risk reduction measures might have been justified (such as upgrading the crossing by fitting barriers) if all the relevant factors at Halkirk crossing had been taken into account and there had been guidance on how they should be considered.
- 186 The report prepared following the RAIB's investigation into the accident at Halkirk was published 23 September 2010 (Report 16/2010). Recommendation 4 was that Network Rail should issue improved guidance, and brief its staff, on assessing the risk from factors not currently included in the ALCRM when carrying out risk assessments and making decisions about implementing risk reduction measures, including methods to be adopted when taking into account the crossing's previous incident and accident history. At the time of publishing this report, Network Rail is still considering its formal response. Network Rail reports that guidance and briefing was given to ORAs about assessing risk from factors not currently included in the ALCRM at an ORA Group meeting on 26 January 2011.

¹⁸ The RSSB has since examined this issue and published research report T821, 'Further work on miniature warning lights at user worked crossings' (the title refers to miniature warning lights rather than miniature stop lights, but they are the same thing). The report is available on the RSSB website, www.rssb.co.uk. The research has concluded that the risk at miniature stop light user worked crossings is substantially lower than that at other types of user worked crossing when the figures take account of levels of usage at each type of crossing. Further research (T936, 'Enhancing the accuracy and functionality of the All Level Crossing Risk Model'), is now under way to consider how the findings from T821 and other relevant studies can be integrated into the ALCRM.

Observation¹⁹

Signage at the crossing

187 The signage at Sewage Works Lane UWC presented information in an unclear manner that did not promote safe use. This was a cause of some of the incidents of road vehicle users not calling the signaller to obtain permission to cross the railway.

188 The current legislation (Section 52(1) of the Transport and Works Act 1992) authorises the operator of a railway or tramway that is crossed by a private road or path to cause or permit the placement near the crossing of signs or barriers. Offences relating to the failure to obey the signage and endangering the safety of passengers committed on level crossing are punishable with a fine or imprisonment (Road Traffic Act 1988 Sec 36 and the Traffic Signs Regulations and General Directions 2002 (and as amended in 2005 and 2008)).

189 The Highway Code forms the basis of the written and practical assessment for new drivers within the UK. Sections 291 to 307 of the Highway Code outline the requirements when driving on the road and how to safely cross a railway or tramway. However, the Highway Code only applies to public roads, and user worked crossings are predominantly found on private property; thus the signage is not fully covered by the Code, but is specified in the Private Crossings (Signs and Barriers) Regulations 1996.

190 This is not a factor in the accident that occurred on 17 August 2010 as the tanker driver had read the sign and acted appropriately when he first visited the crossing (paragraph 46).

191 However, witness evidence indicates that the wording and layout of the signs at Sewage Works Lane UWC (figure 20) had caused other individuals to cross the railway without calling the signaller for permission (including one individual who used the crossing shortly before the accident). Of particular note is the mixture of numbered and un-numbered instructions. If a user read only the numbered items, they would miss the requirement to call the signaller before crossing with a road vehicle. Some users had their attention drawn to the text in bold and focused on the fine associated with failure to close the gates. Overall, the sign at this location was unclear and the requirement for all vehicles to call the signaller was lost within the large amount of other text.

¹⁹ An element discovered as part of the investigation that did not have a direct or indirect effect on the outcome of the accident but does deserve scrutiny.



Figure 20: Sign at Sewage Works Lane UWC

Summary of Conclusions

Immediate cause

192 The immediate cause of the accident was that the tanker driver drove onto Sewage Works Lane User Worked Crossing when it was not safe to do so (**paragraph 40**).

Causal factors

193 The causal factors were:

- a. the tanker driver did not use the telephone before crossing the line, although it was a requirement to do so (**paragraph 41**); and
- b. the tanker driver did not see (and may not have looked for) the train as he approached the crossing (**paragraph 87**).

194 The following factors were possibly causal:

- a. the tanker driver may have been preoccupied with non-work related matters as he approached and crossed Sewage Works Lane UWC, resulting in a lack of focus on the safe method of crossing the railway (**paragraph 65**); and
- b. Anglian Water did not brief its contractors (including JK Environmental) on how their staff could use Sewage Works Lane UWC safely (**paragraph 68, see paragraphs 202 and 203 for details of actions taken by Anglian Water and JK Environmental and Recommendation 1**).

Underlying factors

195 The underlying factors were:

- a. the long waiting times that road vehicle drivers sometimes experienced before being given permission to use Sewage Works Lane UWC led to a high level of non-compliance with the correct procedures for using the crossing (**paragraph 53, Recommendation 2**);
- b. Network Rail's processes for identifying misuse at user worked crossings were not effective in establishing the actual level of misuse at Sewage Works Lane UWC (**paragraph 93, Recommendation 3**);
- c. Network Rail's procedures for responding to incidents involving near-misses and misuse at user worked crossings were unclear and resulted in a lack of engagement with Anglian Water over the history of such incidents at Sewage Works Lane UWC (**paragraph 97, Recommendation 3**);
- d. it is probable that Network Rail did not comply with its own procedures for engaging with authorised users in the periodic risk assessment undertaken in June 2007 at Sewage Works Lane UWC (**paragraph 124**);

- e. the gathering of data as an input to the risk assessment process for Sewage Works Lane UWC was characterised by errors and omissions in the information recorded and the predictable risk arising from the long waiting times for road vehicles at the crossing was not taken into account (**paragraph 130, Recommendations 4 and 5**);
- f. the amount of time devoted to analysing the results from the risk assessment for Sewage Works Lane UWC and considering possible risk mitigation measures was limited (**paragraph 145, Recommendations 4 and 5**); and
- g. no single person or team in Network Rail had a complete understanding of the risk at Sewage Works Lane UWC (**paragraph 159, Recommendation 5**).

Factors linked to the consequence of the event

196 A factor that may have exacerbated the consequence of the accident was the design of the tables in the Class 156 unit (**paragraph 166, Recommendation 6**).

Additional observation

197 Although not linked to the accident on 17 August 2010, the RAIB observes that the signage at Sewage Works Lane UWC presented information in an unclear manner that did not promote safe use of the crossing (**paragraph 187. See paragraph 204 for details of actions being taken by the RSSB**).

Actions reported as already taken or in progress relevant to this report

198 The *Office of Rail Regulation* has:

- written to Network Rail regarding the use of the ALCRM and reminded the company that the ALCRM is not a suitable and sufficient risk assessment in and of itself; and
- required Network Rail to address the risk at all user worked crossings with telephones on the Sudbury branch line by:
 - closing the crossing; or
 - installing a miniature warning (stop) light system (or other means of providing more immediate information to road users on the proximity of a train) (see paragraph 201); or
 - applying measures that enable a signaller to easily identify the location of the train on the branch line using track circuits or other technology.

199 The Department for Transport (Traffic Management Division) is currently working with the RSSB in consultation with the Law Commission (paragraph 200) to review the legislation and other factors associated with level crossings (including the wording of private crossing signage). The Department for Transport has suggested that the Law Commission should consider whether matters relating to private crossing signage should be the subject of research.

200 The Law Commission and Scottish Law Commission are currently reviewing the law relating to level crossings with a view to modernising and simplifying the legal framework governing safety, closure and the creation of public and private level crossings. The project includes consideration of the regulation of signs at level crossings, but not the design of signs. Consultation on draft proposals ran from July to November 2010 and the consultation paper may be found on the Law Commission's website at: <http://www.justice.gov.uk/lawcommission/areas/level-crossings.htm>. The Law Commissions are currently reviewing consultation responses and considering policy recommendations which they hope to publish, together with a draft Bill towards the end of 2012.

201 Network Rail has:

- formally written to all the authorised users at the crossing about the accident and has met with Anglian Water to discuss the safe operation of the crossing;
- moved the telephones at Sewage Works Lane UWC so that the signaller can grant a road user permission to cross the railway before they have to open the gates;
- informed the RAIB that it has started the process of installing miniature stop lights at Sewage Works Lane (and other user worked crossings with telephones on the Sudbury branch line) (paragraph 198);
- taken a number of steps with the purpose of improving the collection and processing of data relating to crossings on Anglia Route, including refresher training and regular feedback for MOMs, additional reviews of data gathered at crossings by ORCCs and establishing a specific occurrence book for events at Sewage Works Lane crossing in Liverpool Street IECC;

- introduced an interactive e-learning training course for those who undertake level crossing site visits to provide an increased level of understanding of risk and to promote consistency in data gathering; and
- reviewed the way that it undertakes level crossing risk management.

Actions reported that address factors which otherwise would have resulted in a RAIB recommendation

202 Anglian Water has:

- Produced a new procedure for internal and external visitors to gain access to the sewage treatment works and reissued the site induction DVD which now includes railway crossings. The site safety information sheet at the works has been updated to include the hazards associated with the level crossing.
- Introduced a rule that only Anglian Water tankers are now used to remove sludge from the site. Additional procedures have been introduced to ensure that all employees, including those who are escorting contractors, must contact a designated member of Anglian Water's staff before they cross the railway at Sewage Works Lane UWC, and must call the signaller before crossing (otherwise they will be liable to dismissal).
- Erected additional signs at the entrance and exit of the access road reminding staff and contractors to follow the correct procedure for crossing the railway.
- Re-written the risk assessment for the site to incorporate the above changes and re-briefed it to all staff.

203 JK Environmental has:

- re-briefed the revised Anglian Water DVD site induction briefing;
- re-issued guidance on level crossings to all staff and incorporated it into its new policy for training new drivers;
- implemented briefings with regard to all types of rail crossing, and on the Highway Code sections applicable to rail crossings;
- introduced a training induction package with regards to rail crossings and their safe use;
- amended method statements to include pre-deployment checks and transit checks referring specifically to railway crossing locations;
- modified risk assessments for the 'travelling' phase of a driver's task to emphasise hazards such as rail crossings;
- introduced an accident and near-miss reporting system which is communicated to all relevant line managers and health and safety staff, with associated review of the lessons to be learnt from reported incidents; and
- adopted a proactive monitoring Safety & Health Improvement Plan (SHIP) covering driver risk safety management.

204 The RSSB has commenced a new research project, 'Research into signs at private level crossings' (T983). The scope of the project includes determining the instructions, messages and/or warnings that should be conveyed to users of level crossings on private roads, and on private land, to ensure that they carry out the required actions correctly and safely. Current signing, road signalling and marking requirements for private road level crossings and level crossings on private land will then be evaluated in the light of human factors good practice and user understanding so that the potential for improvement can be evaluated. If such improvements are shown to be necessary the research will propose alterations to signs for consideration by the railway industry and the Department for Transport.

Recommendations

205 The following recommendations are made²⁰:

Recommendations to address causal, contributory, and underlying factors

- 1 *The intent of Recommendation 1 is for Network Rail to remind authorised 'business' users at user worked crossings of their responsibility to brief their own employees and contractors who may not know how to use such crossings safely.*

Network Rail should use the circumstances of this accident to remind authorised users who are also businesses of their responsibilities to brief staff and contractors on the safe use of user worked crossings (paragraph 194b).

- 2 *The intent of Recommendation 2 is for Network Rail to consider ways of managing the predictable risk that arises at user worked crossing equipped with telephones where long waiting times are frequently experienced by road users.*

Network Rail should consider ways of managing the risk at user worked crossings equipped with telephones where long waiting times can arise as a result of the signaller having no means of knowing where trains are located, and implement any reasonably practicable measures identified (paragraph 195a).

continued

²⁰ Those identified in the recommendations, have a general and ongoing obligation to comply with health and safety legislation and need to take these recommendations into account in ensuring the safety of their employees and others.

Additionally, for the purposes of regulation 12(1) of the Railways (Accident Investigation and Reporting) Regulations 2005, these recommendations are addressed to the Office of Rail Regulation to enable it to carry out its duties under regulation 12(2) to:

- (a) ensure that recommendations are duly considered and where appropriate acted upon; and
- (b) report back to RAIB details of any implementation measures, or the reasons why no implementation measures are being taken.

Copies of both the regulations and the accompanying guidance notes (paragraphs 167 to 171) can be found on RAIB's website www.raib.gov.uk.

- 3 *The intent of Recommendation 3 is for Network Rail to clarify, enhance and provide additional guidance on its requirements for information gathering and consultation with authorised users at user-worked crossings so that local factors can be properly dealt with in the risk assessment process.*

Network Rail should review the relevant procedures in its Operations Manual and make, as a minimum, the following requirements explicit:

- a. correspondence should be sent to all authorised users when trigger risk assessments are to be undertaken inviting them to participate, as well as when routine risk assessments are planned;
 - b. engagement with authorised users should be sought as part of the response to near-miss incidents;
 - c. reference to information held within the controlling signal box such as requests to use the crossing and the occurrence book should be a mandatory element of data gathering for all risk assessments; and
 - d. where businesses are authorised users and have a facility in close proximity to the crossing, independent sources (such as site logs) should be sought and used, where possible, to obtain intelligence on crossing usage for all risk assessments (paragraph 195b and 195c).
- 4 *The intent of Recommendation 4 is to ensure Network Rail reviews the safety of Sewage Works Lane UWC with Anglian Water to identify the measures that can be taken by one or both parties to address the safety risk.*

Taking account of the accident on 17 August 2010 and intelligence in this report about the extent of misuse at the crossing, Network Rail should, in conjunction with Anglian Water, make a thorough and realistic assessment of the risk at Sewage Works Lane UWC, making allowance for local factors at the crossing that influence the risk to users, with a view to identifying and implementing measures to reduce the risk to all users at the crossing. This assessment must include consideration of options to manage the risk of misuse arising from long waiting times for road users (paragraphs 195e and 195f).

continued

- 5 *The intent of Recommendation 5 is for Network Rail to review the costs and benefits of combining the data gathering, processing and assessment roles for level crossing risk assessment, taking account of the possible benefit of one person or a dedicated team having all the necessary knowledge to make an accurate assessment of the risk.*

Network Rail should review its level crossing management processes to establish the costs and benefits of making data gathering, processing and risk assessment of a level crossing the responsibility of a single person or a dedicated team with a comprehensive understanding of the operating environment at that crossing, and make changes to those processes as appropriate in the light of the outcome from the review (paragraphs 195e, 195f and 195g).

- 6 *The intent of Recommendation 6 is for owners and operators of Class 156 units to cooperate on producing a review of the crashworthiness performance of the tables and determine whether the table design should be changed. This review may have relevance for other classes of rolling stock which share a similar design of table to the class 156.*

Owners of class 156 units should assess whether or not there is a case for improving the crashworthiness performance of the tables on Class 156 units and implement any measures found to be reasonably practicable. When undertaking this assessment, the owners should seek the co-operation of operators of Class 156 units (paragraph 196).

Appendices

Appendix A - Glossary of abbreviations and acronyms

ALCRM	All Level Crossing Risk Model
IECC	Integrated Electronic Control Centre
LGV	Large Goods Vehicle
MOM	Mobile Operations Manager
NXEA	National Express East Anglia
ORA	Operations Risk Advisor
ORCC	Operational Risk Control Coordinator
OTDR	On-Train Data Recorder
RAIB	Rail Accident Investigation Branch
RGS	Railway Group Standard
RSSB	Rail Safety and Standards Board
SMIS	Safety Management Information System
UWC	User Worked Crossing

Appendix B - Glossary of terms

All definitions marked with an asterisk, thus (*), have been taken from Ellis's British Railway Engineering Encyclopaedia © Iain Ellis. www.iainellis.com.

All Level Crossing Risk Model	A model used by Network Rail to evaluate the risk at level crossings.
Authorised User	A person or body having the right to cross the railway at a specific private level crossing (and those visiting, trading with or servicing the authorised user).
Bogie	A metal frame equipped with two or three wheelsets and able to rotate freely in plan, used in pairs under rail vehicles to improve ride quality and better distribute forces to the track.*
Crashworthiness	The capacity of a vehicle to protect its occupants during an impact*. A design method that involves designing the train structure so that it is able to perform to a given standard during a collision. Group Standard GM/RT2100 defines the requirements for new vehicles.
Diesel Multiple Unit	A multiple unit train whose source of power is a diesel engine.*
Emergency Brake	The position on the brake control that applies the maximum possible braking effort. This is beyond the normal service brake position.
Miniature Stop Lights	Small red and green lights mounted on a board adjacent to a user worked level crossing or footpath crossing. The lights are operated by the passage of trains. These are sometimes called miniature warning lights.
Mobile Operations Manager	An individual who manages specified operational issues within an area of Network Rail infrastructure including being the first line of management attendance at operational incidents.
Office of Rail Regulation	The safety regulator for the railways in Great Britain.
On-Train Data Recorder	An electronic device wired into a train's electrical systems for the purpose of recording with respect to time key control and system conditions.
Railway Safety Principles and Guidance	The documents produced by the Office of Rail Regulation providing guidance on the design and operation of light railways, railways and tramways.
Safety Management Information System	A computer database used by the railway industry to record incidents and accidents.
Track Circuit	An electrical or electronic device used to detect the absence of a train on a defined section of track using the running rails in an electric circuit.*

Appendix C - Key standards current at the time

GM/RT2100 Requirements for Rail Vehicle Structures, Issue 3, October 2000	Rail Safety & Standards Board
NR/L2/OPS/100 'Provision, Risk Assessment and Review of Level Crossings', Issue 2, 1 June 2008.	Network Rail
NR/L3/OCS/041, Operations Manual, Issue 23, 5 June 2010	Network Rail

Appendix D - The All Level Crossing Risk Model

Railtrack's Automatic Level Crossing Risk Model (Auto LCRM) was developed from 1993 onwards by Arthur D Little for railway staff to use to assess the risk present at automatic half barrier crossings, using a standardised methodology. The initial model, presented to the British Railways Board in 1994, allowed estimation of level crossing risk for any particular site according to crossing type, levels and types of use, rail traffic density and line speed. The model worked within the bounds of quantified risk analysis conducted during its development. It was used in 1994 – 96 to support a number of risk assessments associated with lines of route, individual crossings and more generally in Railtrack Zones.

The model was developed steadily, and updated to V2.2 in 1997. This was the first version to be released for widespread use across Railtrack. This version included the ability to distinguish between trains with differing speeds and lengths, an improved user interface, and other refinements. At this stage the model was only regarded as robust for automatic crossings, because 'the fundamental work on human safety performance in relation to sighting times and reasons for user distraction or indiscipline have not been sufficiently explained.'

Version V3 of the model was released in late 2002. Changes from V2.2 included (among others) remodelling of user misuse, revised weighting for blocking back, reviewing the pedestrian risk model, and the relationship between risk and train length. The changes required recalibration of the model, which involved running it for all automatic crossings, and this was completed late in 2003. Some changes were then made to the multipliers for 'deliberate abuse' and 'blocking back (road vehicles unable to exit from the crossing)', and V3.1 of the model was then rolled out and used by Network Rail until 2006. In this form it allowed risk areas to be identified and mitigated, and was used as a tool to help understand where it would be sensible and cost effective to upgrade particular crossings.

Further RSSB research projects built on this foundation to develop the Auto LCRM model into the ALCRM which could be used to assess risk at all crossings, including UWCs. New risk assessment methodologies were incorporated into the model for passive crossings, based on earlier research. Safety benefit calculations were included in the ALCRM in order to facilitate comparison of different level crossing upgrade options, and a number of other improvements were introduced into the existing risk assessment methodology.

The first version of the model was available for trial in early 2006. It was subsequently verified against the functional specification (which had been defined in 2002/03 by a steering committee of industry experts and managers) and calibrated. This showed, among other things, that risk associated with passive crossing use is broadly in line with that predicted by RSSB's Safety Risk Model (the ALCRM and the SRM had not been specifically aligned at that time). Network Rail then designed and delivered training courses for the model for its various level crossing practitioners.

In January 2007, Network Rail launched the ALCRM for use across its network. Its intention was to standardise the assessment of risk for all types of crossings across the network. The purpose of the ALCRM is to support and inform decision making on level crossings in accordance with standard NR/SP/OPS/100 'Provision, Risk Assessment and Review of Level Crossings'.

The relevant section of the Network Rail Operations Manual, procedure 5-16 'Level crossing risk management', requires that each level crossing shall be subject to a risk assessment at not more than three-yearly intervals. Additional assessments are required following changes in traffic patterns or after an accident or serious incident. The assessment regime is supplemented by six-monthly inspections by Network Rail maintenance staff.

The ALCRM requires the type of crossing to be identified and data from a site survey to be input. This includes sighting distances, line speeds and a census of crossing users. Procedure 5-16 lists three types of census: a 'full census' covering a 24 hour period, for which special arrangements need to be made; a 'quick' census covering a 30 minute period between 09:30 hrs and 16:30 hrs on a weekday, for which the results are multiplied by 27 to give a total estimated usage per day; and an estimate. Procedure 5-16 states that a quick census is the standard requirement for public vehicular crossings and the first preference for other crossings unless use is very light.

The ALCRM classifies risk in the following ways:

- Individual risk (identified by a letter A (high) to M (low)), which is the risk to an individual using the crossing on a frequent basis (typically 500 times per year); and
- Collective risk (identified by a number 1 (high) to 13 (low)), which is the risk to all individuals involved, including users, train crew, passengers and pedestrians.

The model gives the crossing a risk score for each risk category, and identifies the factors contributing to this. It is intended to support and inform an assessor, but the assessor is required to exercise judgement in reviewing the output. Consideration of risk mitigation options is required to be conducted for all crossings following risk assessment.

The model calculates fatalities and weighted injuries, which is a statistical measure, before and after any mitigation is applied. This is a numeric value which can be used for the purposes of cost-benefit analysis.

The ALCRM has been subject to enhancement in the last two years including recalibration to align the risk levels with the Safety Risk Model.

Appendix E - Crashworthiness standards

The Class 156 unit was designed to the requirements of British Rail Load Case Documents 1, 2 and 3 (referred to as LCD 1, LCD 2 and LCD 3). LCD 1 covered the structural requirements for all items of equipment mounted to the vehicle body. LCD 2 covered the structural requirements for the body including the vehicle end structure under longitudinal loads. LCD 3 covered the structural requirements for interiors.

During the 1980s, there were no mandatory crashworthiness specifications for energy absorption or controlled structural deformation. Consequently the Class 156 cab structure does not include specific features such as crumple zones or crush tubes.

At the onset of privatisation, Railway Group Standards (RGS) started to replace British Rail documents and all three Load Case Documents were replaced by RGS equivalents in 1993.

The introduction of the RGSs coincided with the introduction of new crashworthiness requirements. However these did not apply retrospectively to existing vehicles unless they were being modified. Class 156 vehicle end and body structures have never been modified and hence the Class 156 has never had to comply with the crashworthiness requirements of the RGS.

The current RGS which defines the structural requirements for railway vehicles is GM/RT2100 issue 4. This standard defines the proof and crashworthiness requirements to be applied to vehicle structures. From its first release in July 1994 and up to December 2010, GM/RT2100 stated that new or modified vehicle designs should be able to absorb 0.5 MJ of energy in over-riding collisions.

By the time the Class 156 units were refurbished between 1995 and 1998, the requirements for interiors originally in LCD 3 had been transferred to Railway Group Standard GM/TT0121 (1993). This compulsory standard was soon replaced by GM/RC2502 (1994) and BR/BCT609 (1996) which were both issued as codes of practice, ie they were not mandatory.

GM/RC2502 defined the requirements applicable to tables but these had evolved significantly. In particular, the tables had to be able to withstand 1500 N applied longitudinally along the edge of the table without permanent deformation. This is twice the original requirement. In addition, the standard required the post-yielding behaviour to be such that it does not endanger the safety of passengers and crew.

BR/BCT609 introduced new crashworthiness tests for the seats and tables aimed at governing their behaviour when loaded beyond the proof strength. These tests subjected the seats and tables to the impact from two crash dummies accelerated with a crash pulse between 5.75 g and 8 g. The pass-fail criterion was a set of injury criteria levels measured on the dummies that should not be exceeded during these tests. The RAIB calculated the average deceleration rate during the impact at Sudbury and has estimated it to be between half and a third of the requirement in BR/BCT609.

Only GM/RC2502 would have been applicable at the start of the refurbishment of the Class 156. As part of the refurbishment, the original seats were replaced with new ones. This was a modification to the original design and despite GM/RC2502 being only voluntary the seats complied with its proof requirements.

The original table tops which had rotted away were also replaced but the original table legs and table edges were kept. They were thus unmodified and did not have to comply with the new requirements.

This report is published by the Rail Accident Investigation Branch,
Department for Transport.

© Crown copyright 2011

Any enquiries about this publication should be sent to:

RAIB	Telephone: 01332 253300
The Wharf	Fax: 01332 253301
Stores Road	Email: enquiries@raib.gov.uk
Derby UK	Website: www.raib.gov.uk
DE21 4BA	