

EXTRACT OF RECORDING OF RADIOCOMMUNICATION.

This is the transcript of radiocommunication on frequency 131.10 Mhz between Brussels ACC (Airways) and the aircraft G-APEC (BEA LINE 706).

Communications between ACC and other aircraft are omitted.

TIME (GMT)	FROM.	RECORDED INTELLIGENCE.	REMARKS.
1001	G-APEC	Goodmorning Brussels Bealine seven OH six is passing one eight for one nine zero and estimating Wulpen at zero four	Channel quiet.
	ACC	Seven OH six cleared er Salzburg green one to maintain flight level one nine zero on reaching	
	G-APEC	Bealine seven OH six	
1002		.	Channel quiet.
		.	
		.	
1005	G-APEC	Brussels Bealine seven OH six checked Wulpen zero four we're now level one nine zero estimating Mackel one zero	
	ACC	Seven OH six Roger	
		.	
1009.46 s.	G-APEC	We're going down er seven OH six - We're going down Mayday Mayday Mayday	) Two voices, - ) part - ) simultaneous
		Mayday Mayday Mayday we're going down vertically -	
		Bealine seven zero six ??? ??? out of control	
1009.55 s.		Out of <u>control</u> -----	Continual background whine - Blowing noises.

1009. <u>58 1/2 s.</u>		- <u>No</u> rudder - + + -	+ Crunching noises.
		? ? ? -	??? Weak speech.
		-----	
		-----	- Blowing noises
1010. <u>11 s.</u>		- <u>AH</u> this is it -	
		-----	
		+ +	+ Crunching noises.
1010. <u>25 s.</u>	ACC	- <u>Aircraft</u>	Brussels transmitting
	G-APEC	- Missed -	simultaneously with
			BEALINE 706 open mic.
1010. <u>28 1/2 s.</u>	ACC	- <u>Craft</u> calling mayday aircraft	Background whine no
1010. <u>30 s.</u>		calling mayday would you trans-	longer heard
		mit transmit in blind over	
1010. <u>40 s.</u>		- - - ??? ??? - - -	Bealine 706 transmission
			believed to cease here.
1011	ACC	- - - - -	Brussel appears to have
			left transmitter on,
			-back- ground noises,
			speech and loudspeaker
			transmission heard
1011. <u>37 1/2 s.</u>		- -	

Several calls from BRUSSELS ACC to BEALINE 706 remained without any answer from the aircraft.

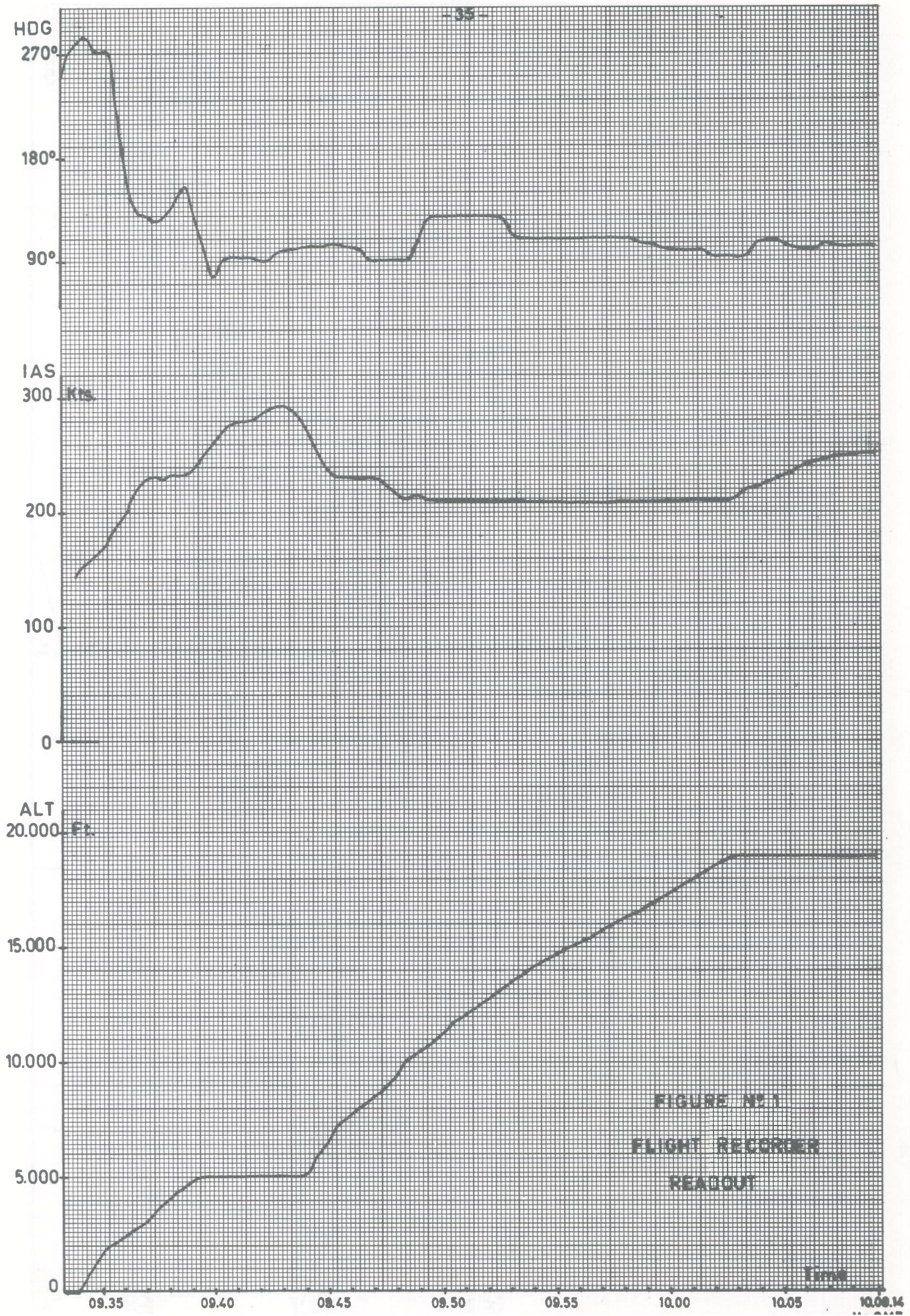

FIGURE NO. 1  
FLIGHT RECORDER  
READOUT

Time

10.00.14

FIGURE N° 2

Concluding section of track of G-APEC on 2<sup>nd</sup> October 1971  
derived from flight recorder data

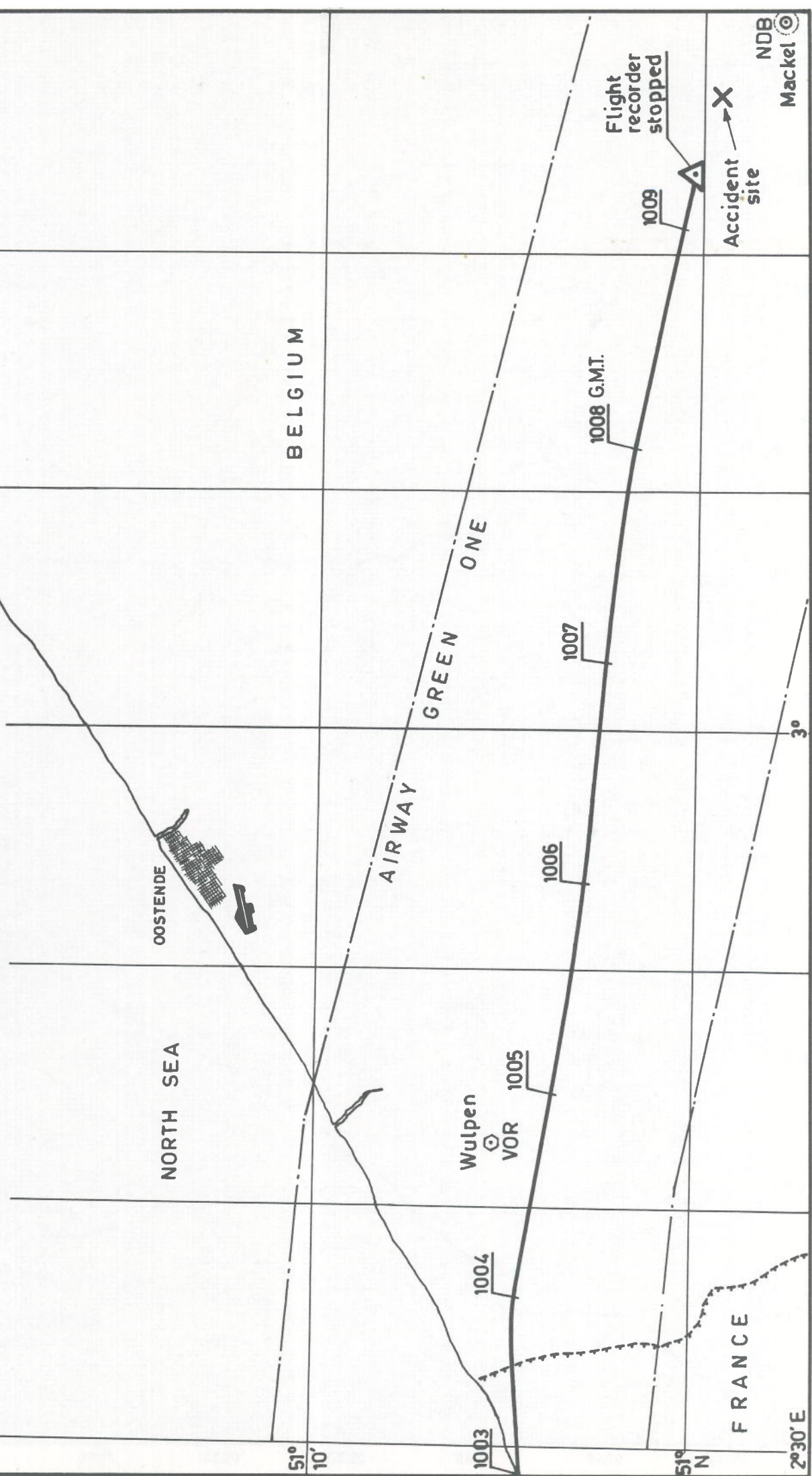



Photo by Isselee, Brussels, Belgium.

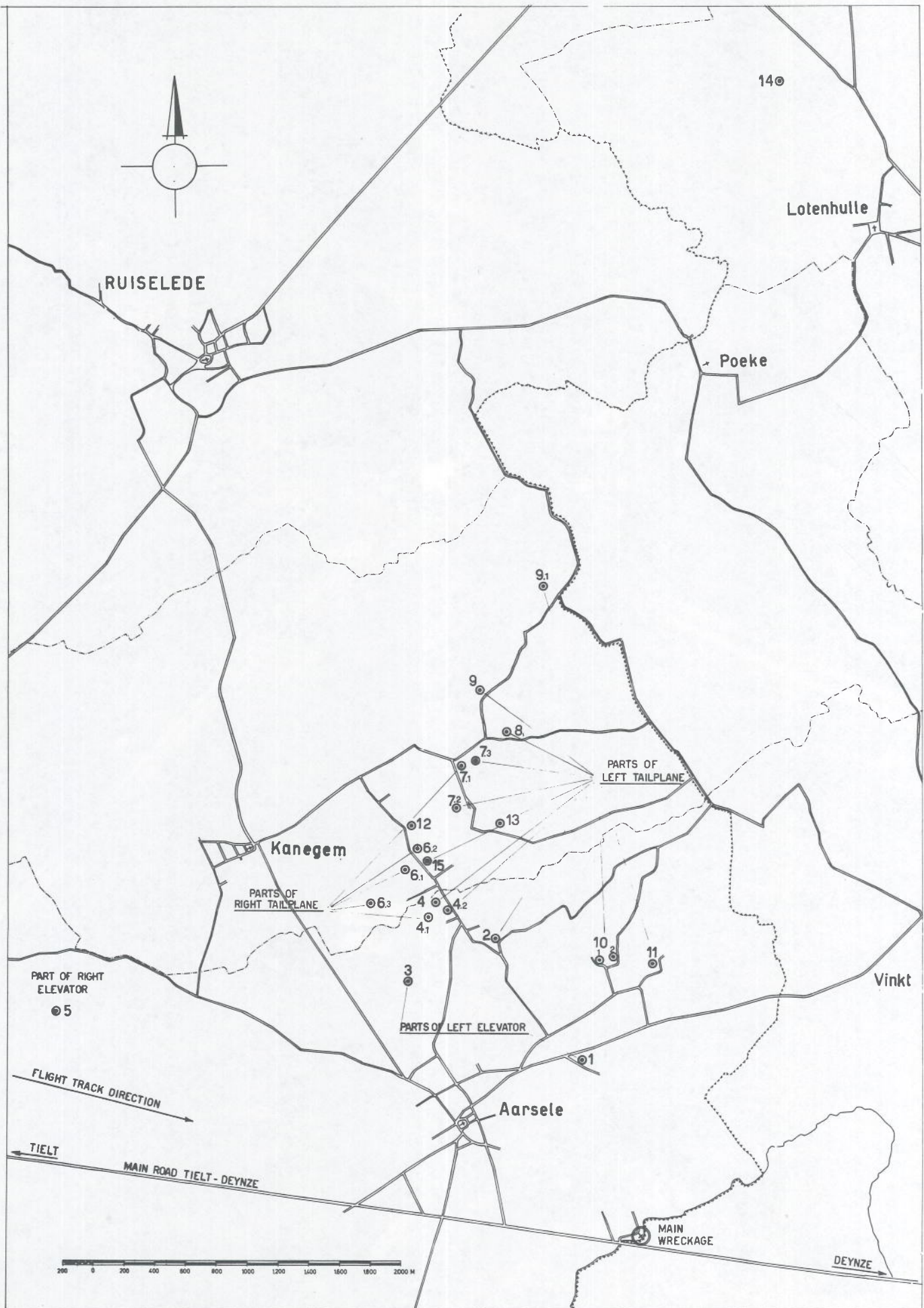

FIGURE N°4 \_ PLOT OF PIECES SEPARATED FROM G-APEC

N°	DESIGNATION.
	<u>Left Elevator.</u>
1.	Left elevator, inboard section, with trim and spring tabs.
3.	Left elevator, outboard section.
	<u>Right Elevator.</u>
5.	Right elevator, outboard section, with part of tab.
	<u>Left Tailplane.</u>
2.	Left tailplane leading edge, centre section.
4.	Left tailplane leading edge, outboard section with tip.
4.2.	Rear spar of centre section of left tailplane, with hinge C.
7.2.	Left tailplane, rear spar, between hinges B and C.
7.3.	Left tailplane, part of upper skin.
8.	Left tailplane, part of lower skin.
	Rib, right tailplane, front to centre spar.
	Two small pieces (skin plate).
9.	Four small pieces of left tailplane.
9.1.	Left tailplane, part of lower skin.
10.	Left tailplane, part of upper skin, between front and centre spars. (10.1. : one large piece and 10.2.: two small pieces).
11.	Left tailplane upper skin, centre section between centre and rear spars.
13.	Nose rib assy and left tailplane rear spar.
15.	Left tailplane centre spar (three pieces).
	<u>Right Tailplane.</u>
4.1.	Right tailplane leading edge, outboard section with tip.
6.1.	Right tailplane rear spar, with hinges C and D.
6.2.	Right tailplane, part of upper skin.
6.3.	Right tailplane leading edge, centre section.
7.1.	Right tailplane, part of upper skin.
12.	Right tailplane, nose rib assy.
14.	Elevator fabric.

KEY to Figure 4: plot of pieces separated from G-APEC.

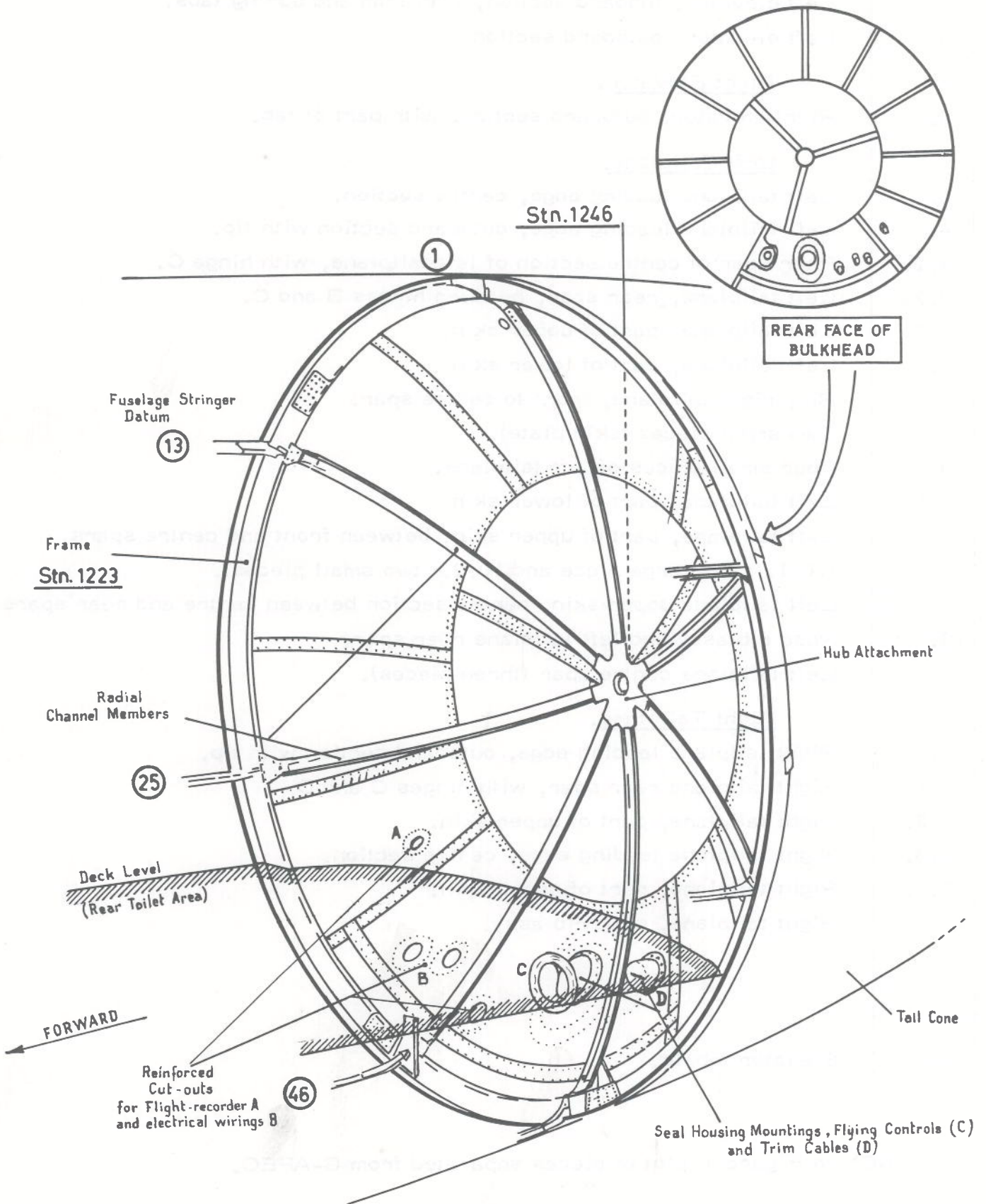

FIGURE Nº 5 - REAR PRESSURE BULKHEAD



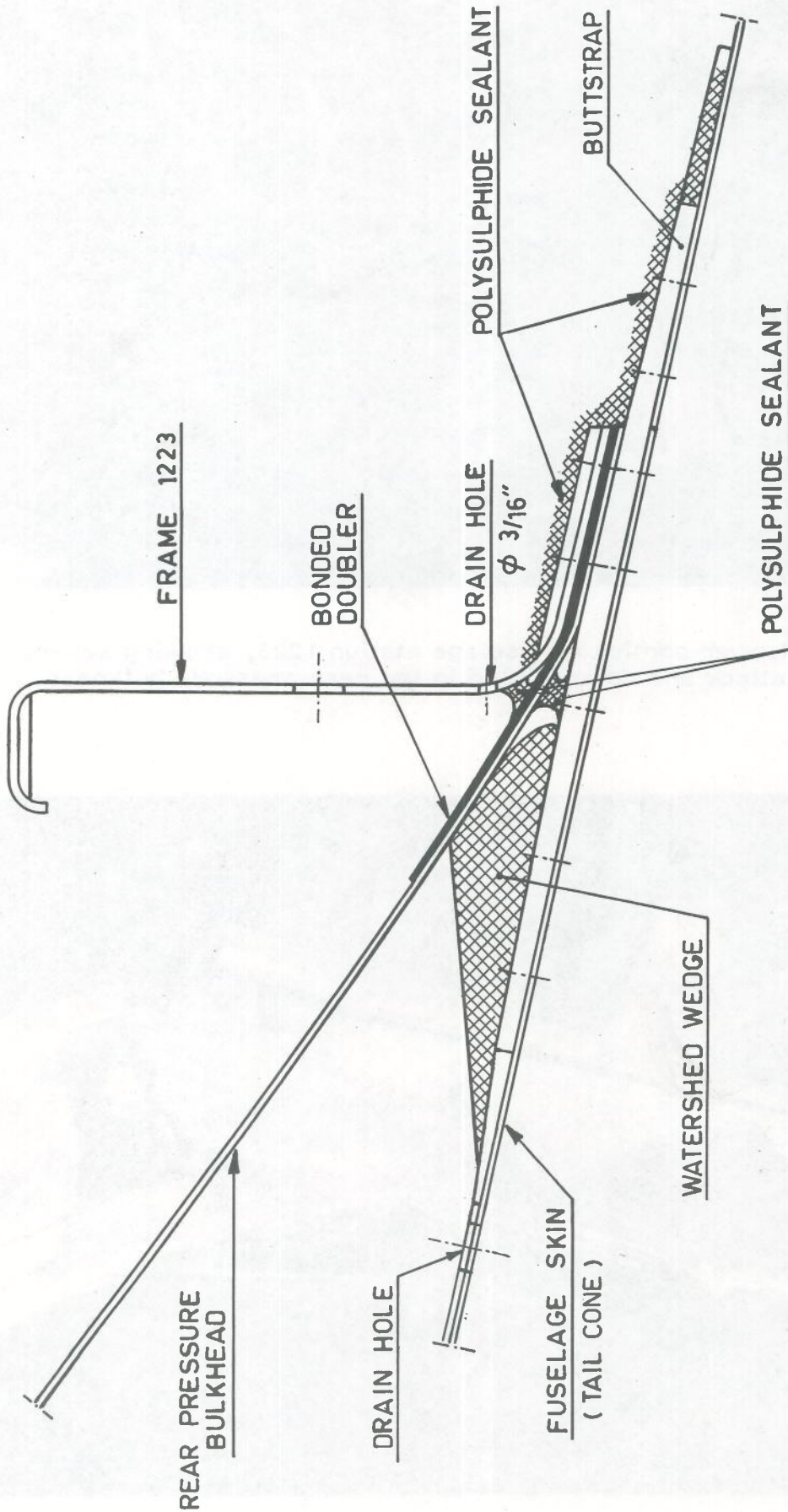

FIGURE NO 6. CROSS SECTION OF STRUCTURE ASSEMBLY AT STN 1223. IN CENTRE LINE OF FUSELAGE



Figure n° 7: Lower portion of fuselage station 1223, showing severe corrosion attack and delamination in the rear pressure bulkhead.



Figure n° 8: Lower portion of frame 1223 and rear pressure bulkhead, showing tar marks.

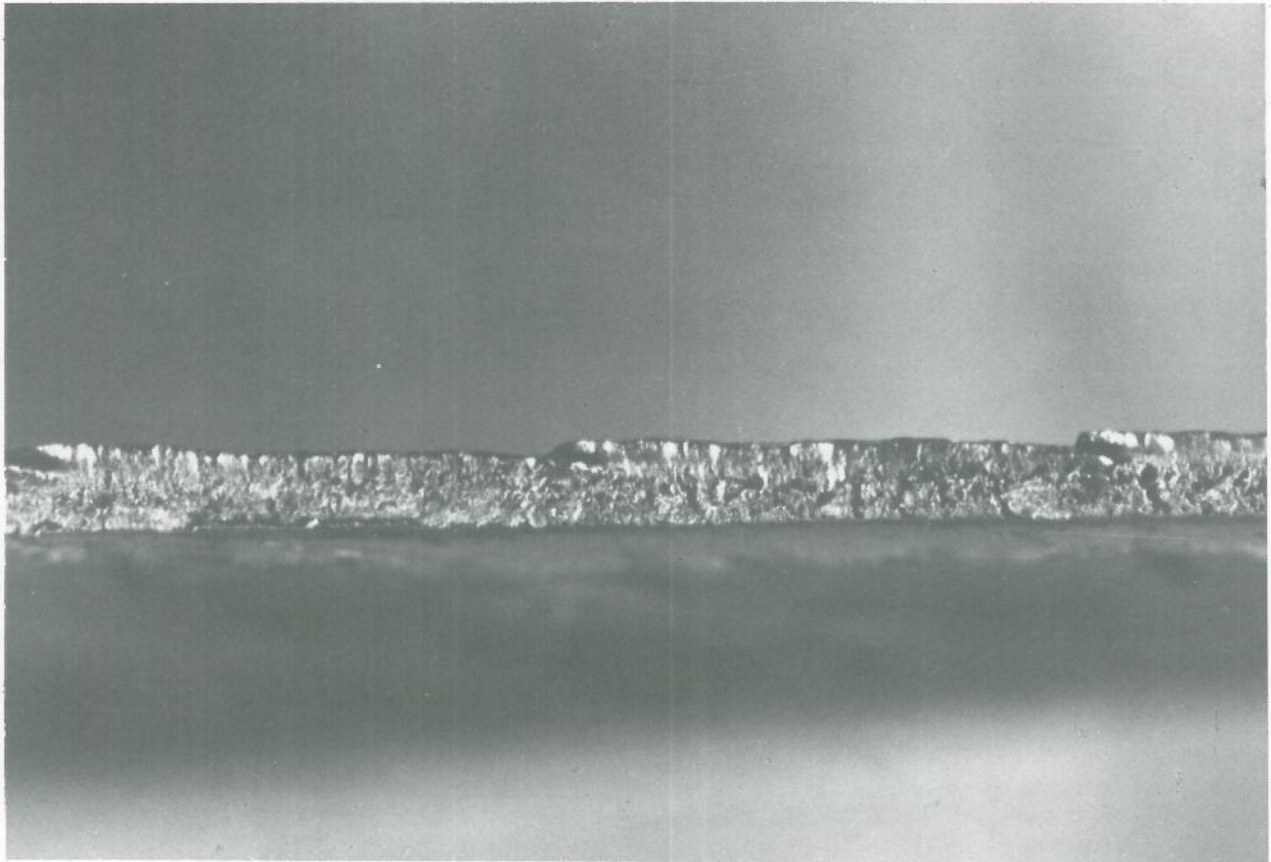

Figure n° 9: Typical "step," marks along tears in the rear pressure bulkhead.



Figure n° 11: Reconstruction of the rear pressure bulkhead.

VIEW LOOKING FORWARD

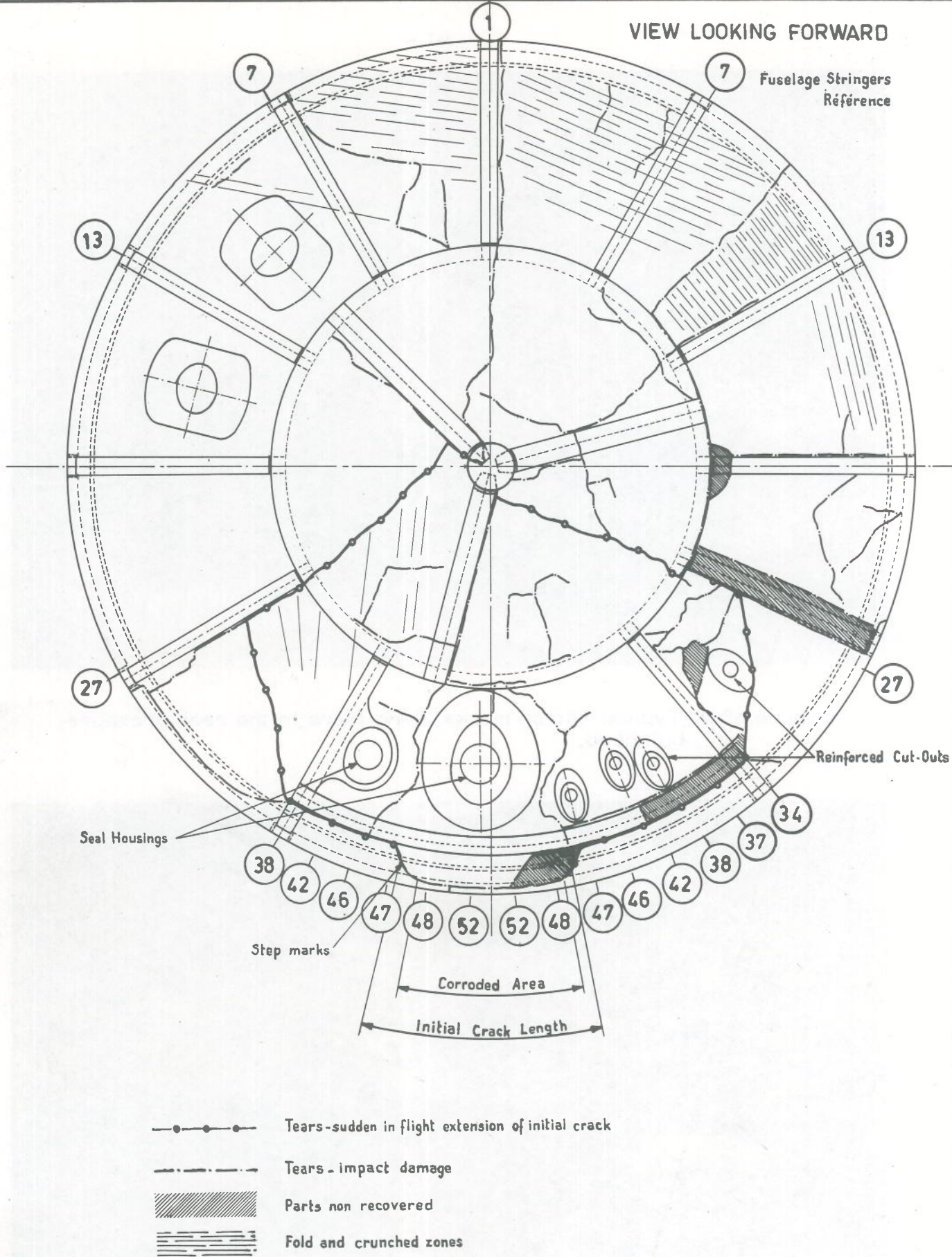
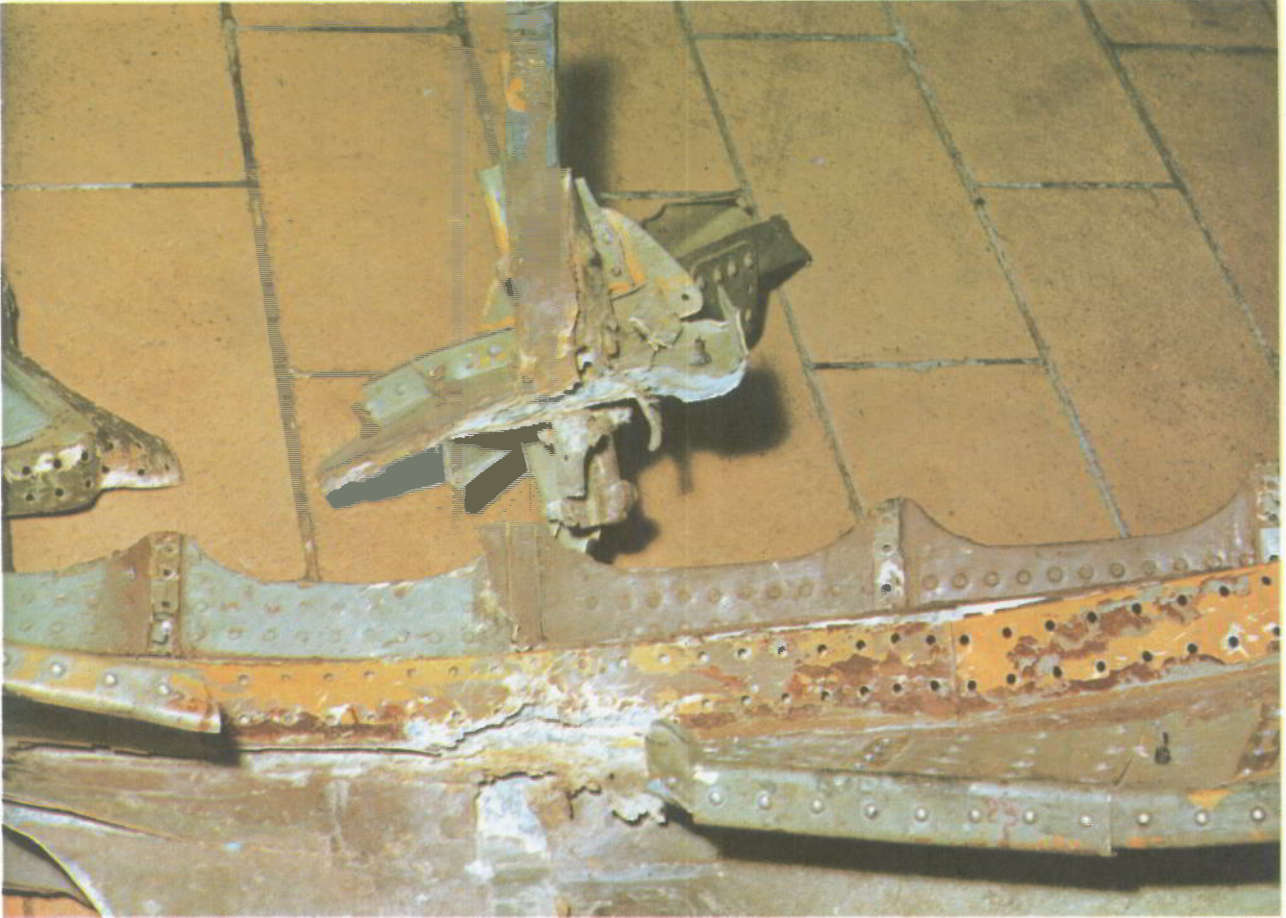
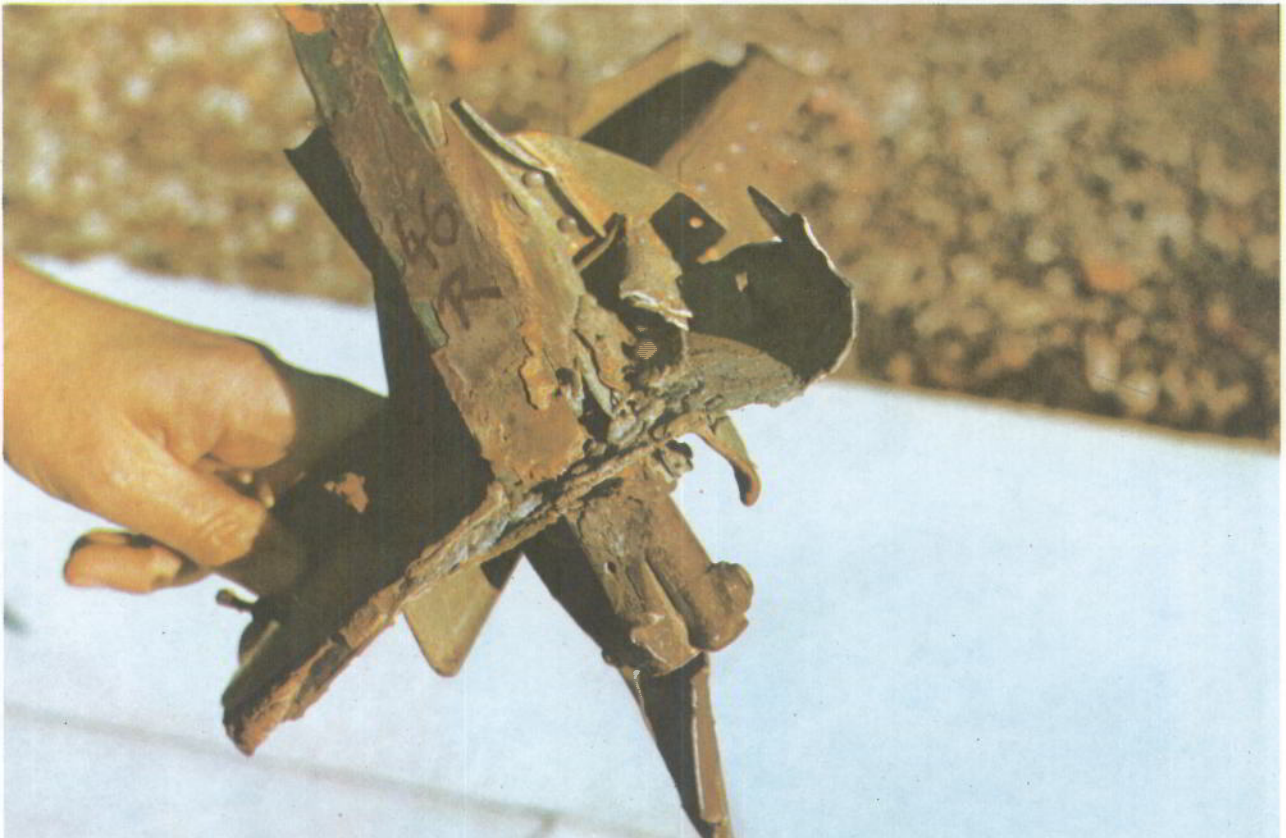

FIGURE N° 10. TEARS IN REAR PRESSURE BULKHEAD



a) Frame 1223.



b) Vertical bracing member.

Figure n° 12: Fuselage station 1223 at stringer 46, showing severe corrosion at vertical bracing member.

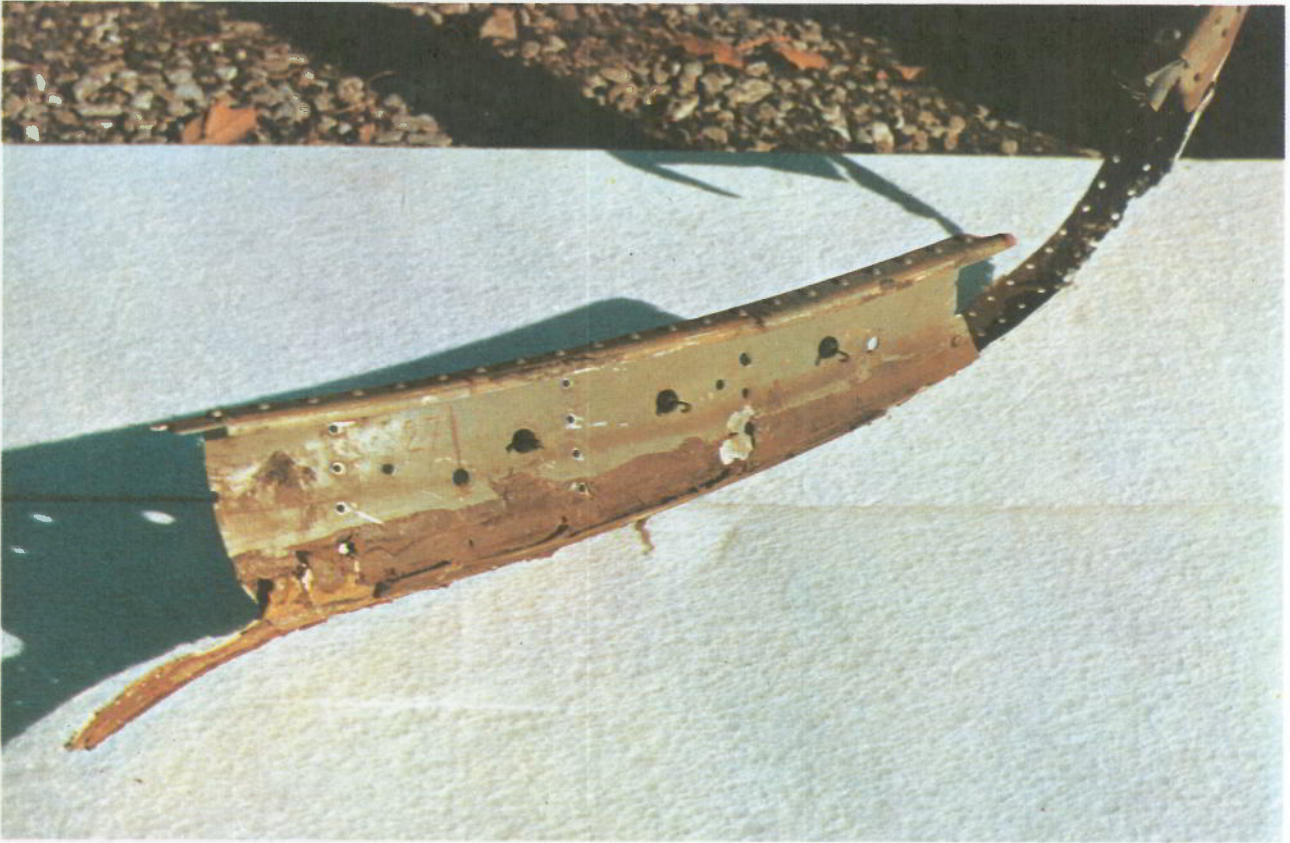

Figure n° 13: Lower portion of frame 1223, rear face, showing polysulphide sealant and blocked drain hole.

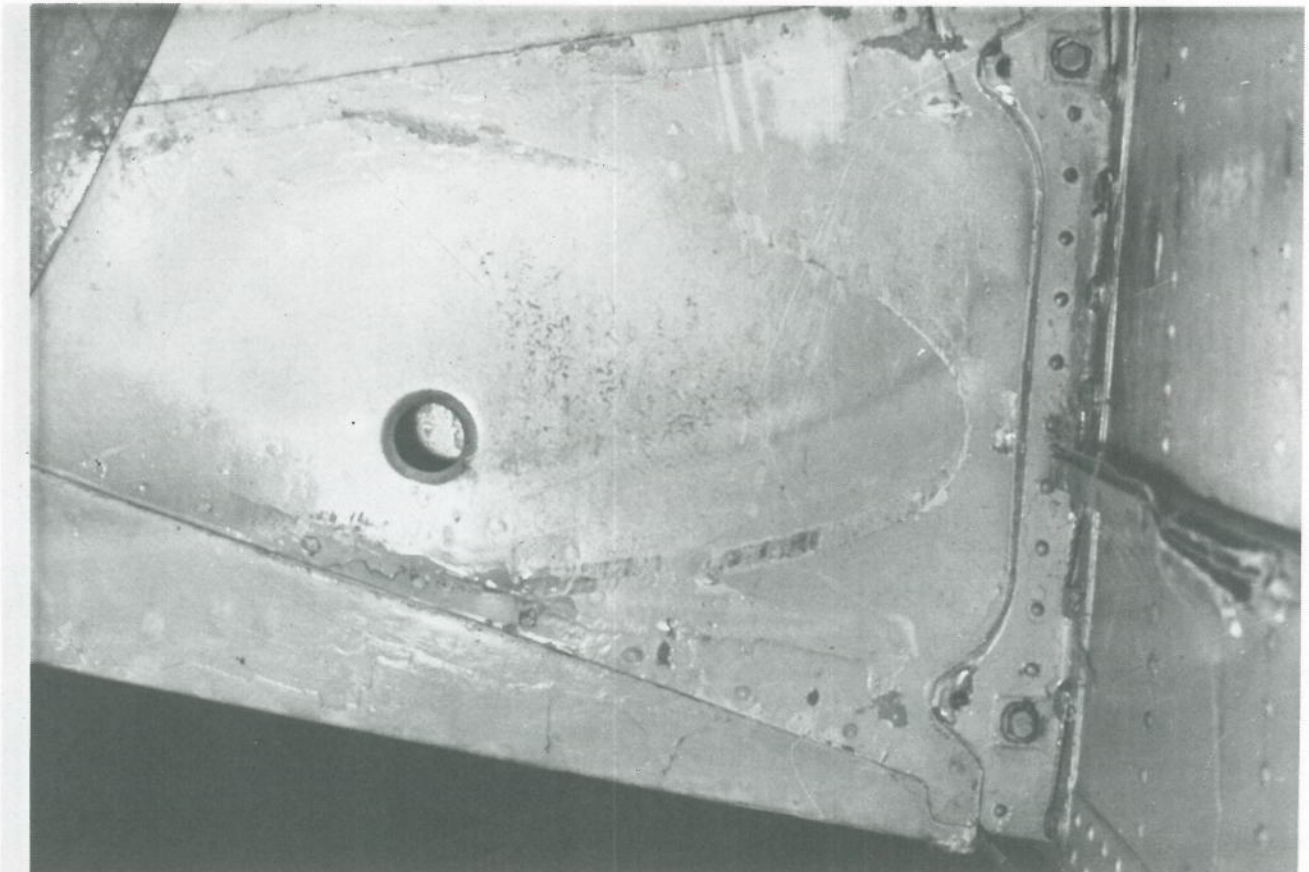

Figure n° 15: Typical hinge beam (Stn 89-LH-inboard face) showing impression of elevator leading edge.

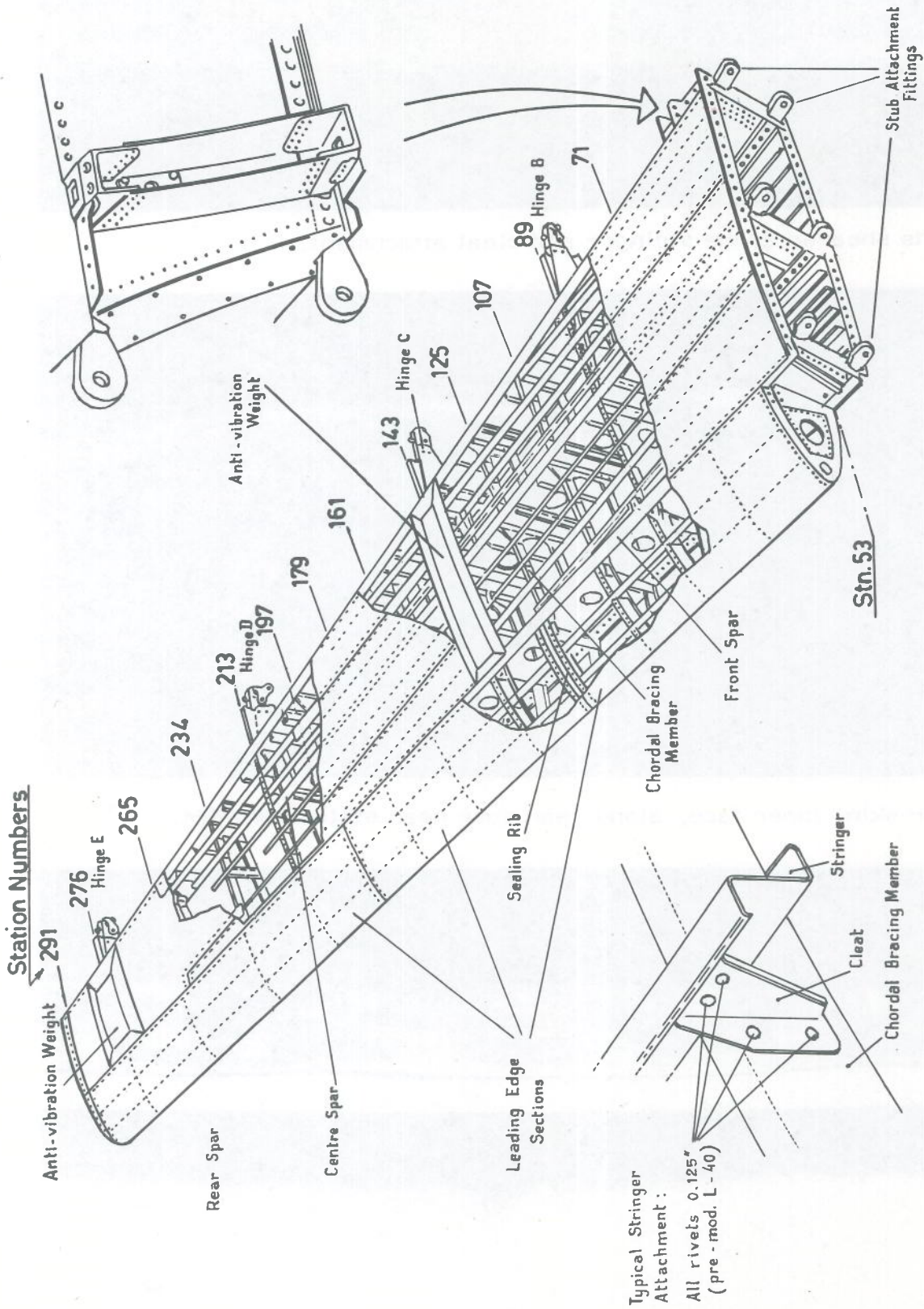
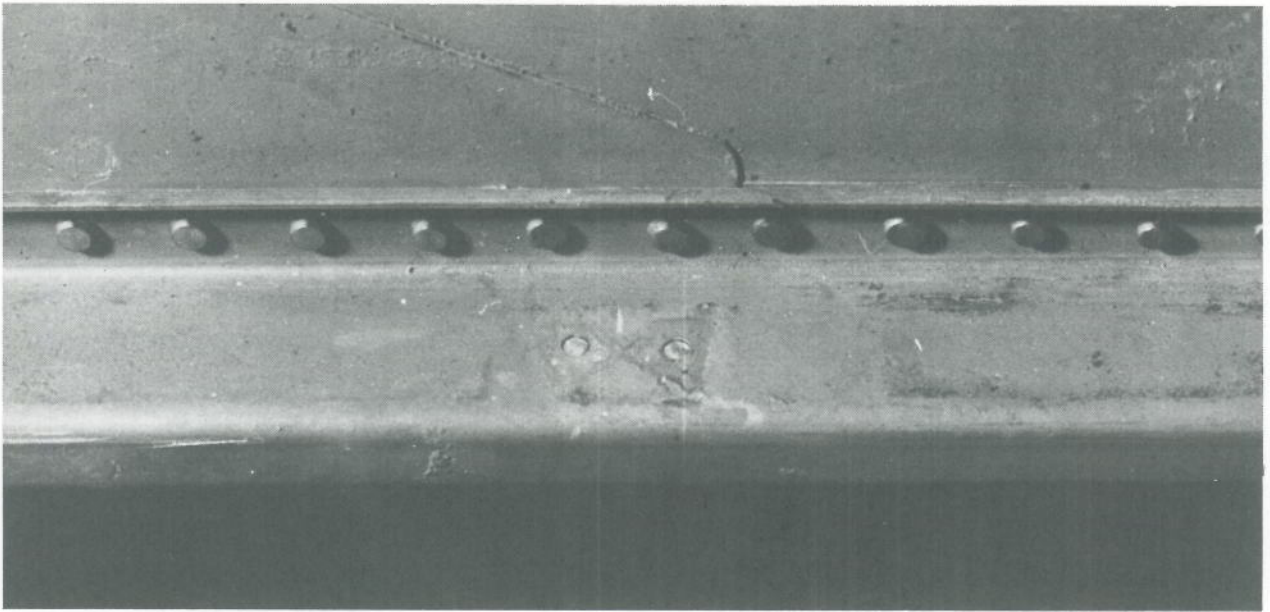

FIGURE NO 14 - TAILPLANE STRUCTURE - ( Right tailplane shown )



a) Rivets sheared at the stringer and cleat attachment.



b) Upper skin, inner face, along rear spar near station 143, RH.

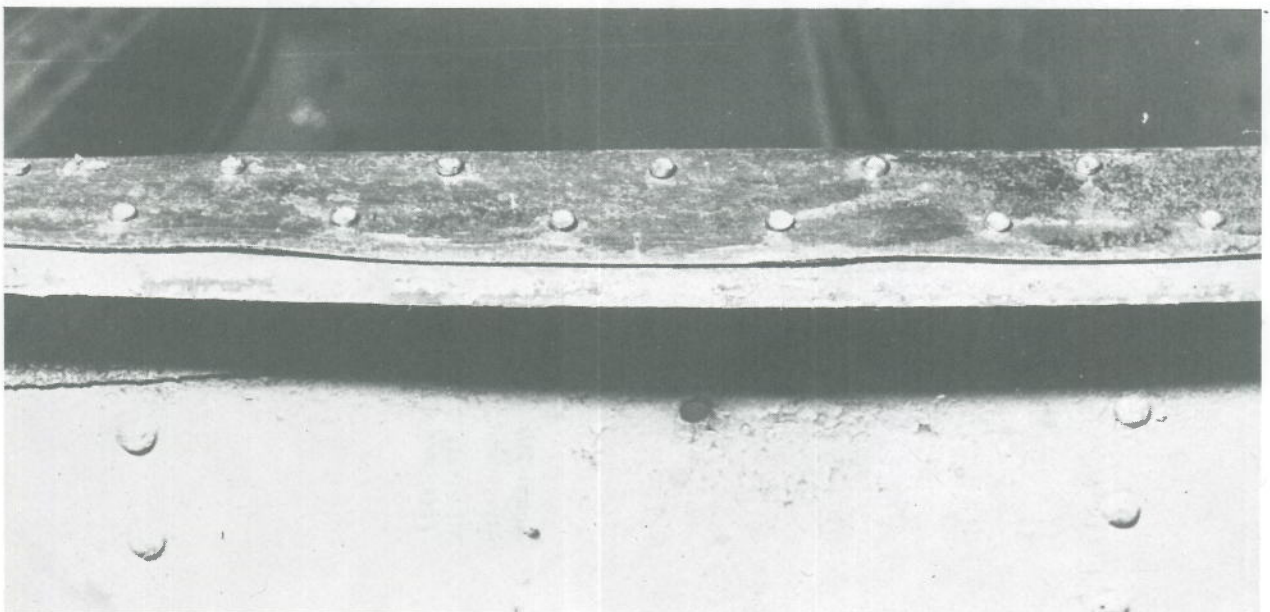

c) Rear spar, upper cap, near station 143, RH

Figure 16: Typical failures in tailplanes.





Figure n° 17: Typical micrograph taken in lower portion of rear pressure bulkhead plating showing severe intergranular corrosion at front face.